



CLASSIC

11019



Page
Seite
Pagina
Pàgina
Oldalszám
Lpp.
页码



Page
52





Page
28





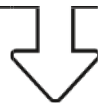
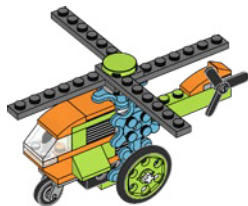

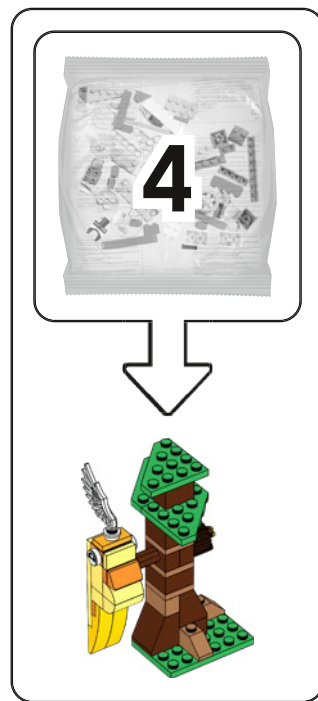

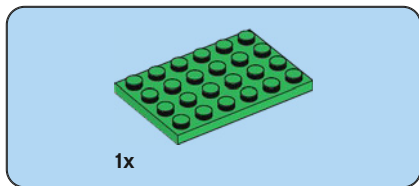

1

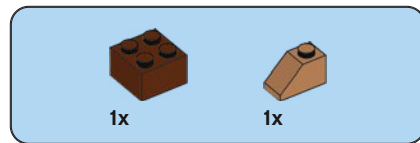
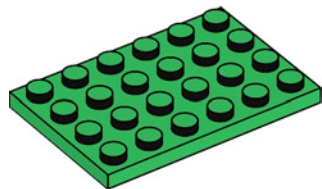

2

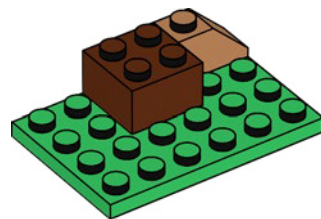

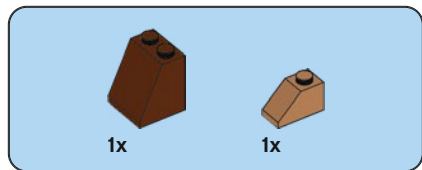

3

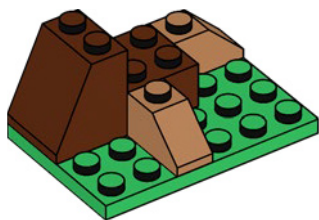

8

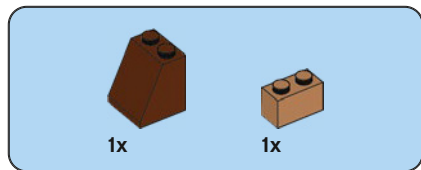

4

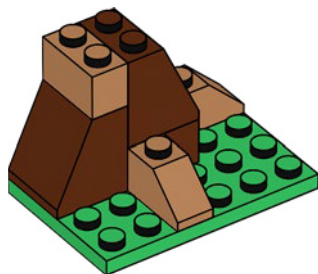

5

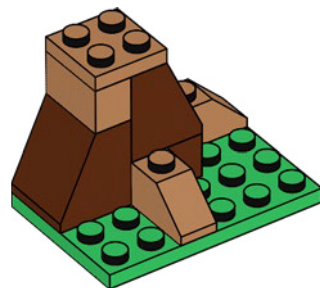



1x



1x

6

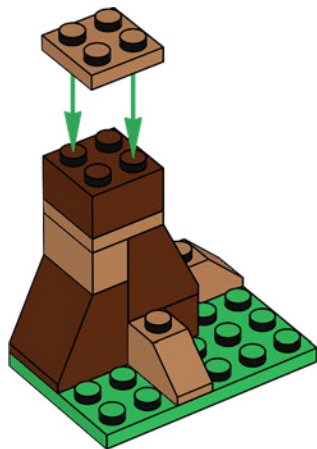



2x

7

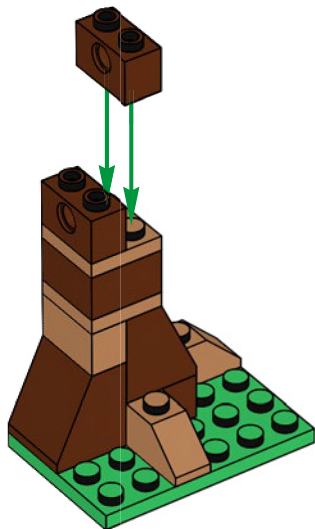

1x

8

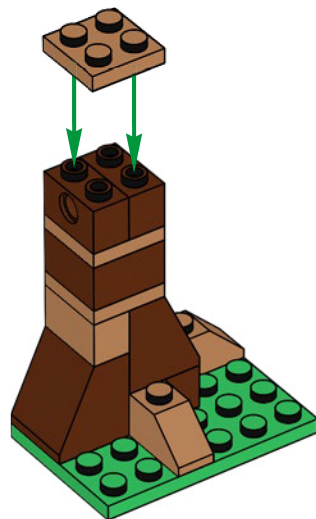



2x

9



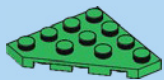

1x

10

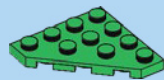
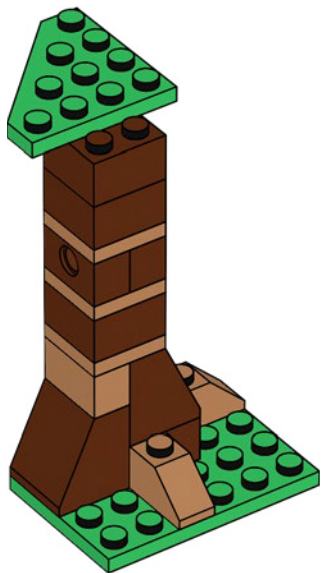

1x

11

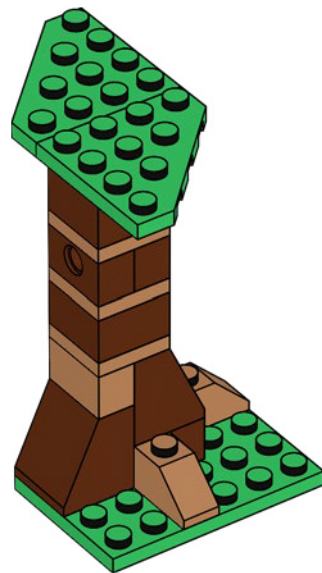



1x

12

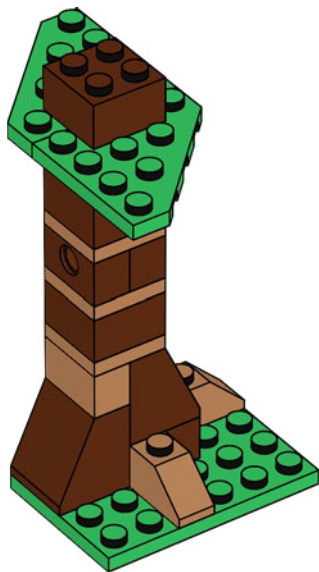

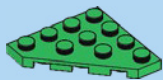

1x

13

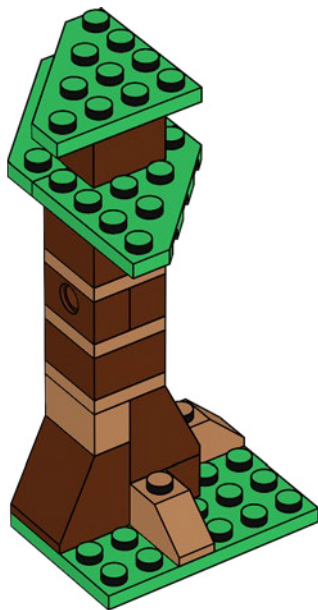

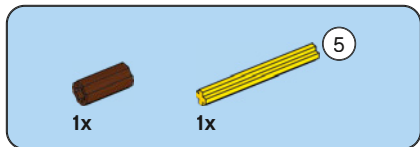

14

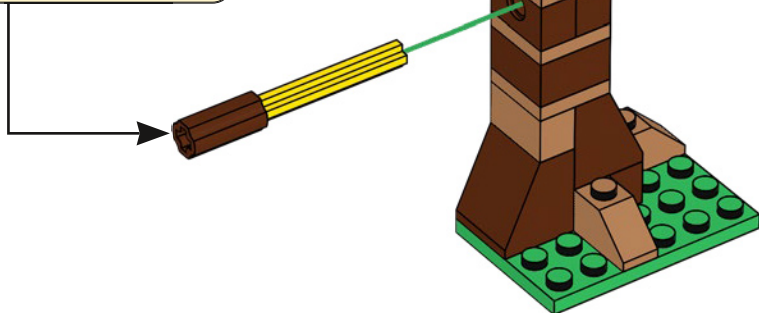
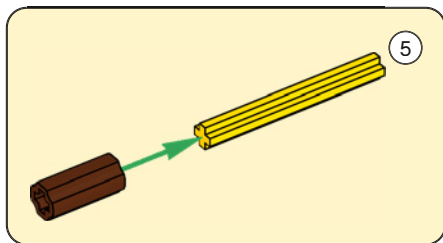



1x

15

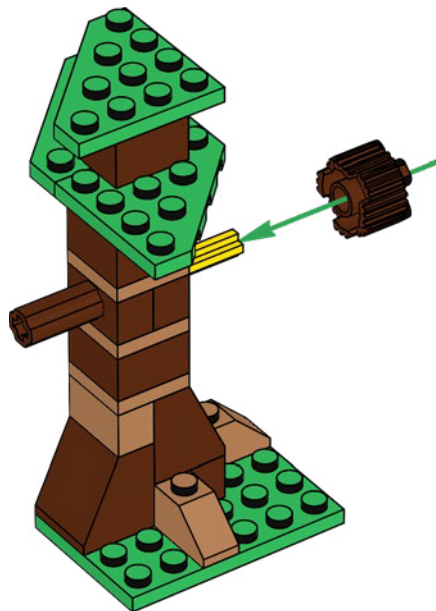

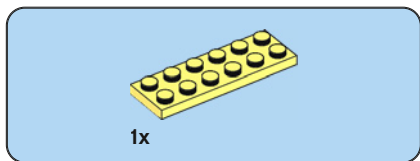
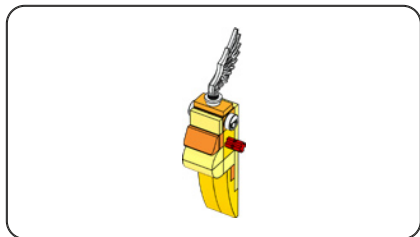

16

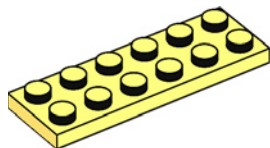



2x

17

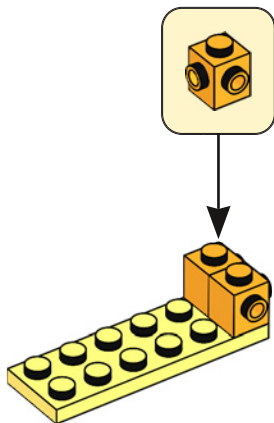

1x

18

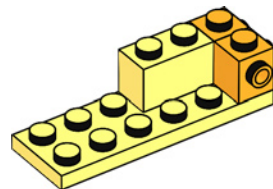

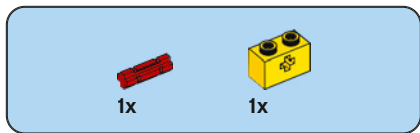

19

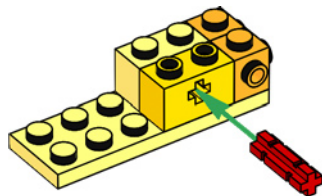

20

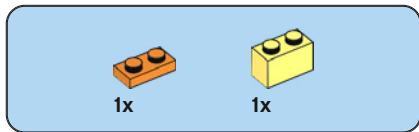

20

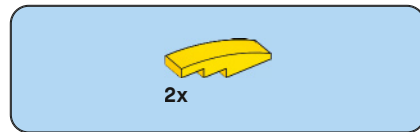
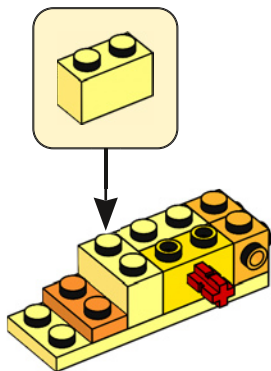

21

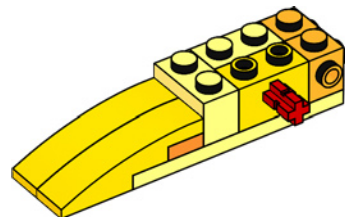



1x



1x

22

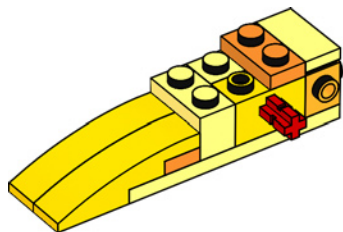



1x

23

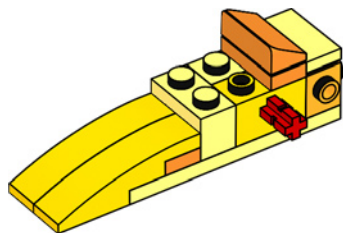

2x

24

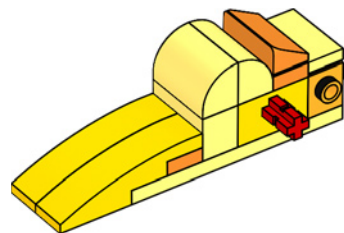



1x

25

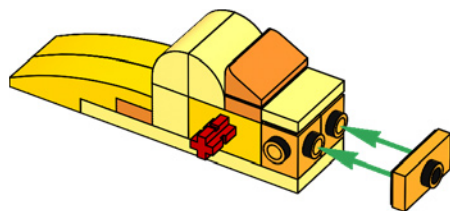



26

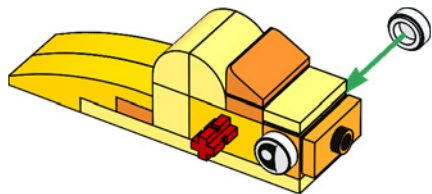

1x

1x

27

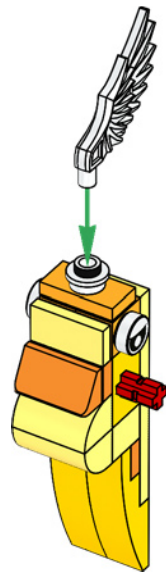

28

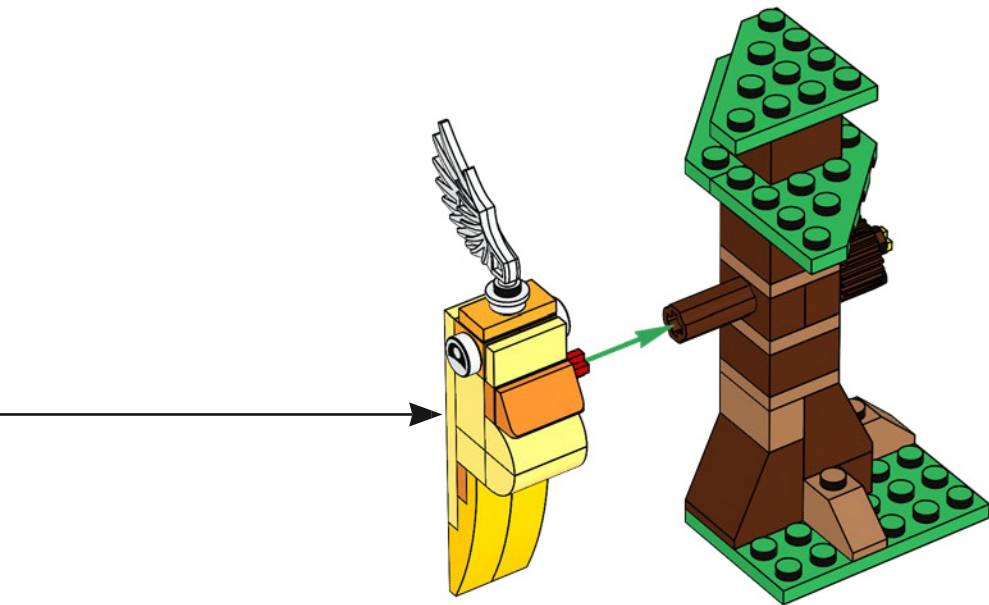

29



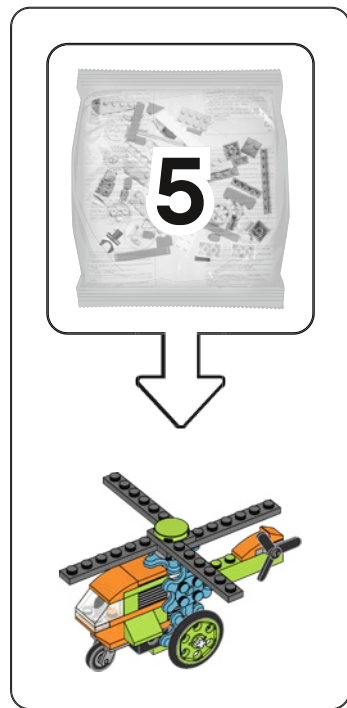

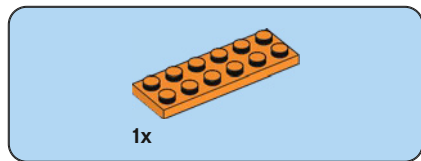

1

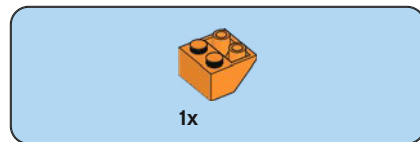
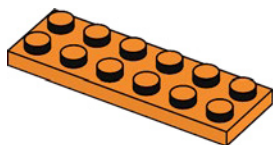

2

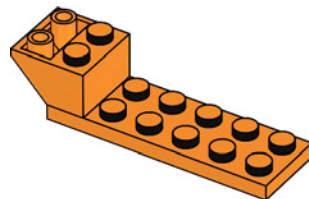



2x

3

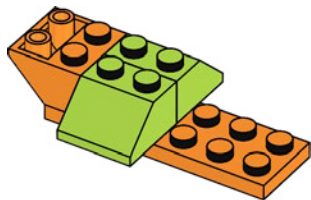

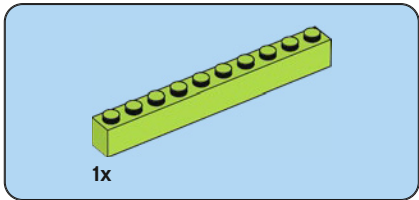
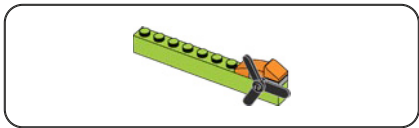

4

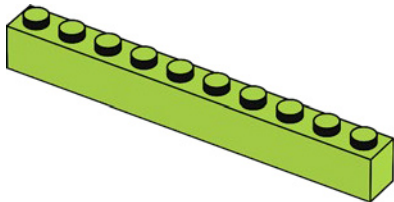

5

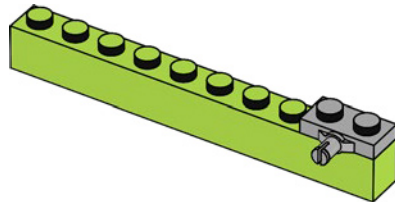



1x



1x

6

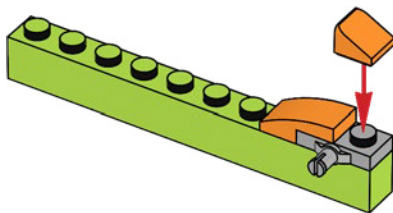

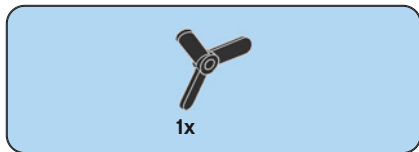

7

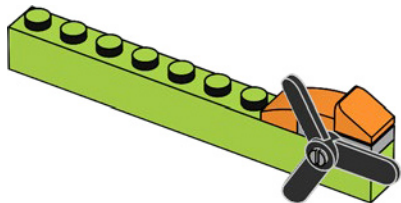

8

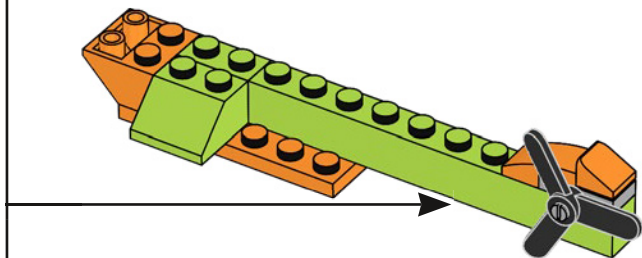



1x

9

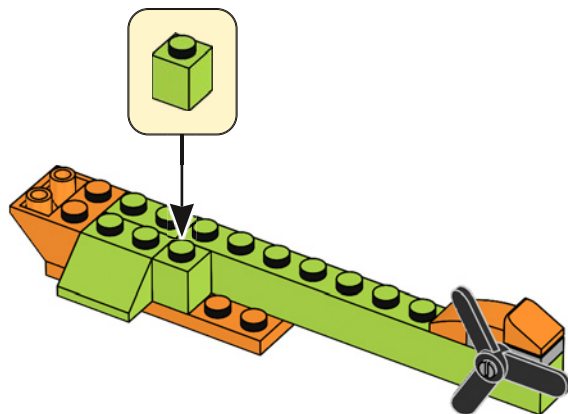

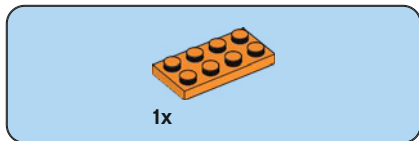

10

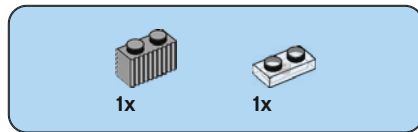
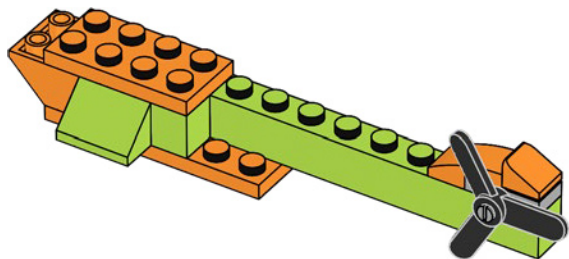

11

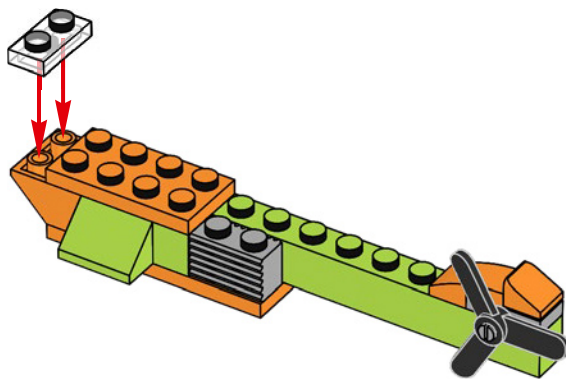

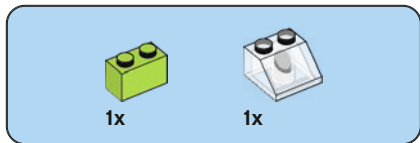

12

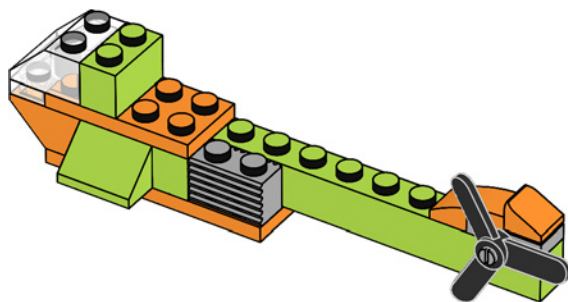



1x



1x

13

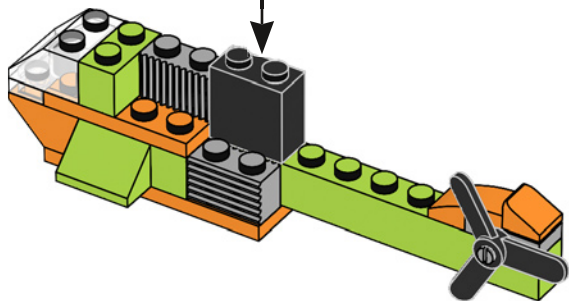
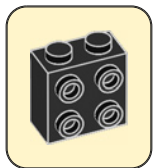

1x



1x

14

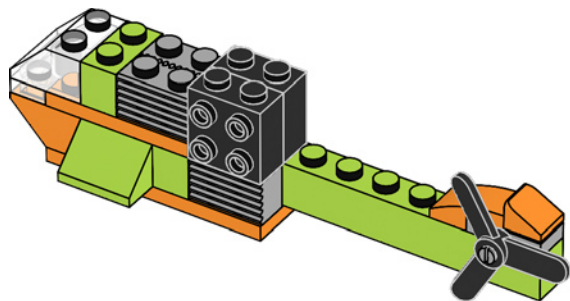



1x



1x

15

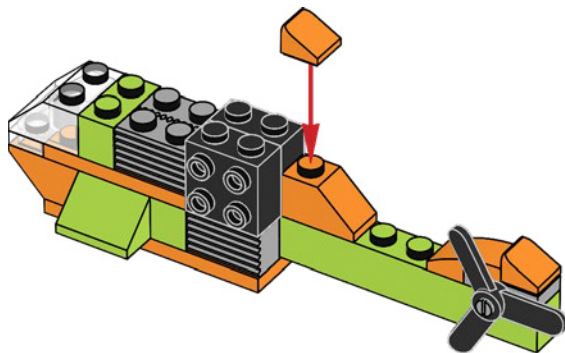

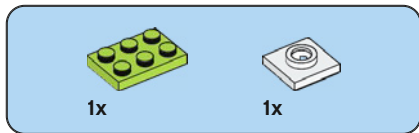

16

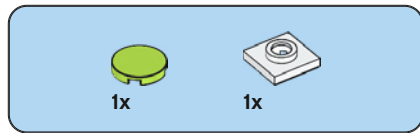
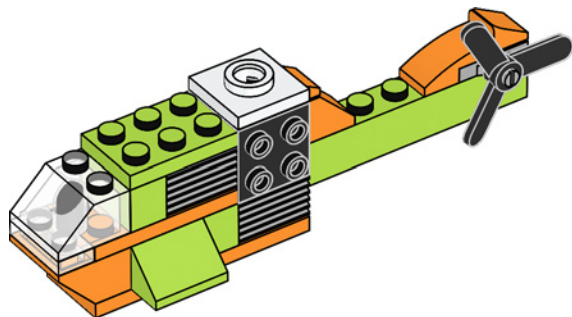

17

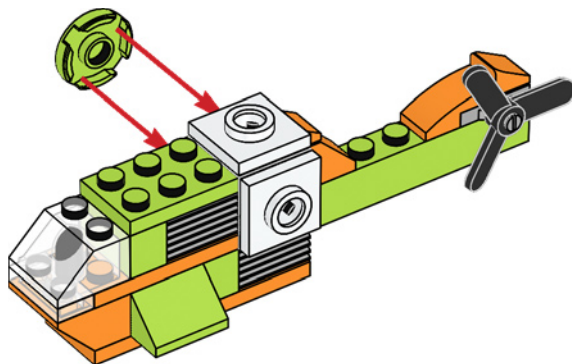



1x



1x

18

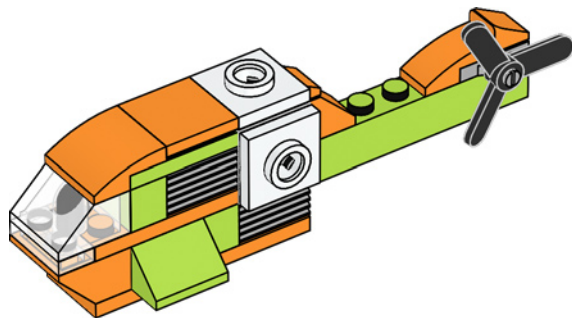



2x

19

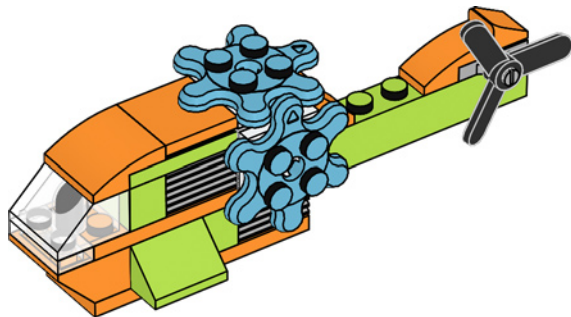

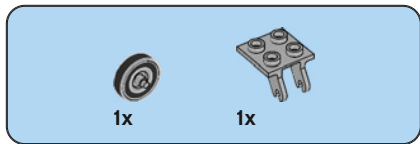

20

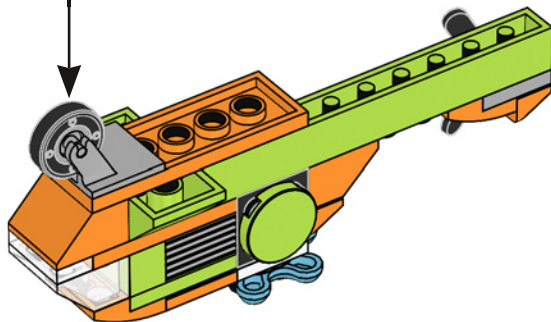
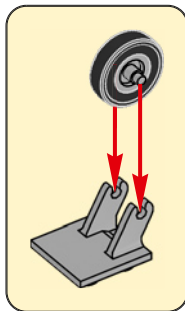



1x

21

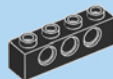
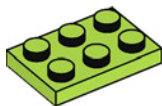

1x

22

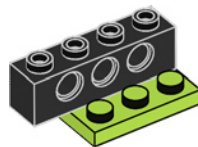



1x



1x

23

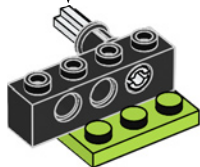
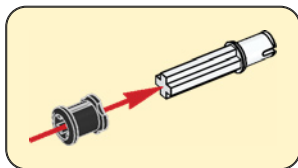

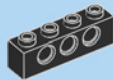

1x

24

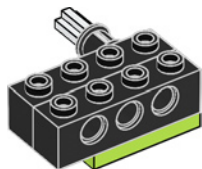

1x

25

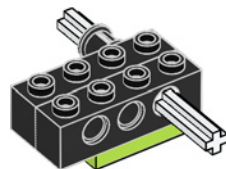

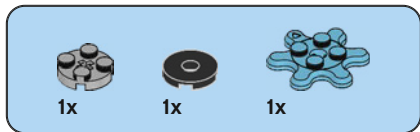

26

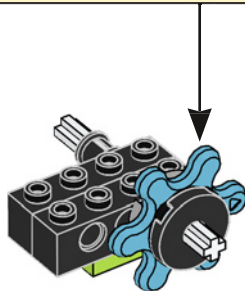
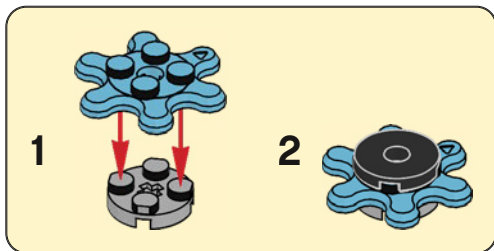

27

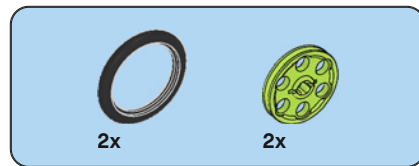
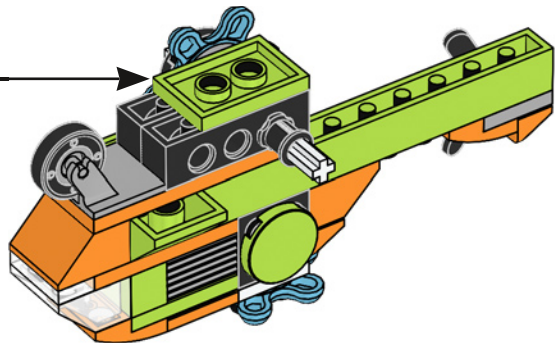

28

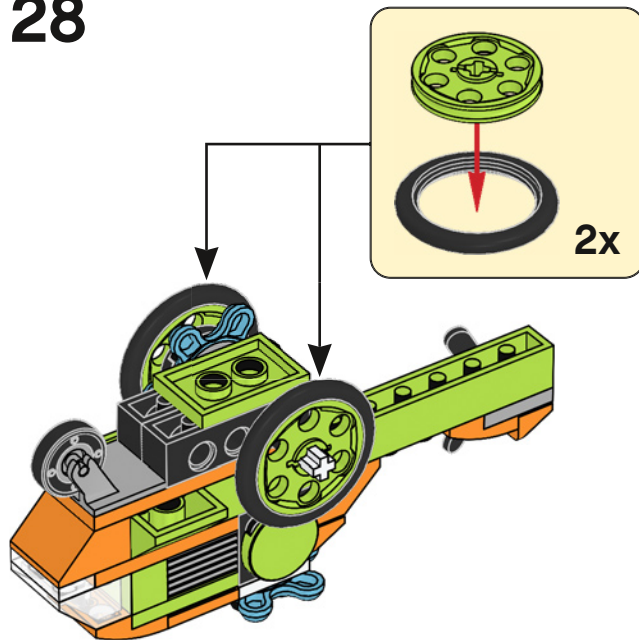

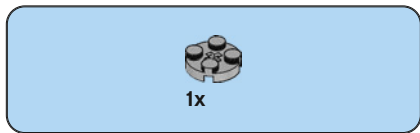
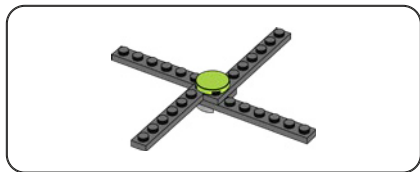

29



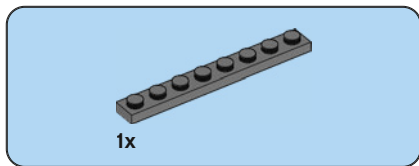

30

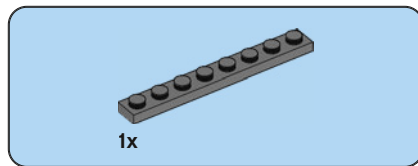
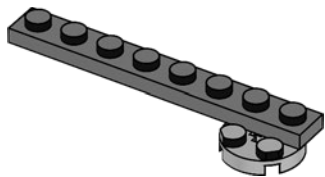

31

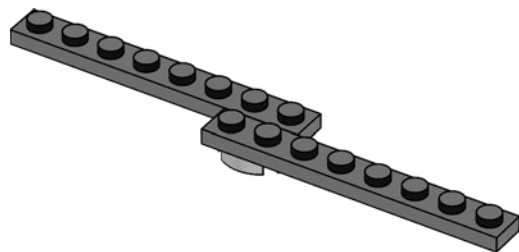

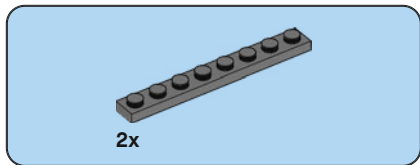

32

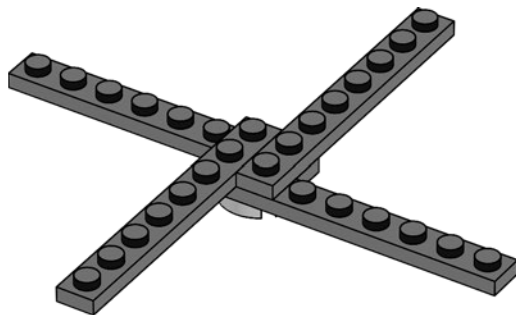

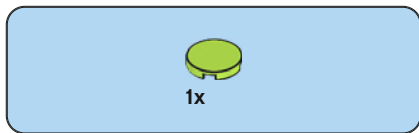

33

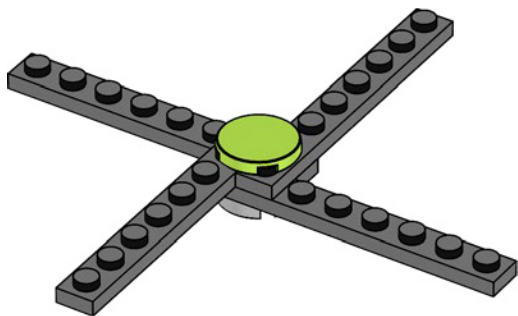

34

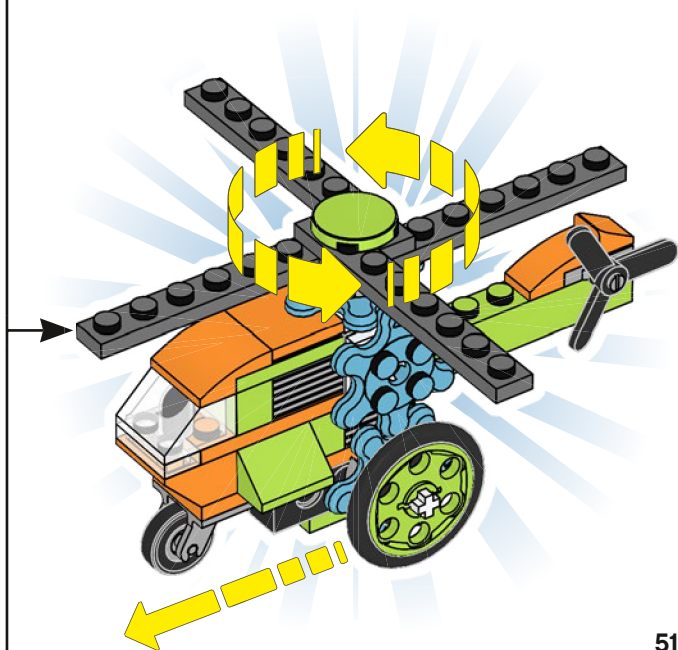

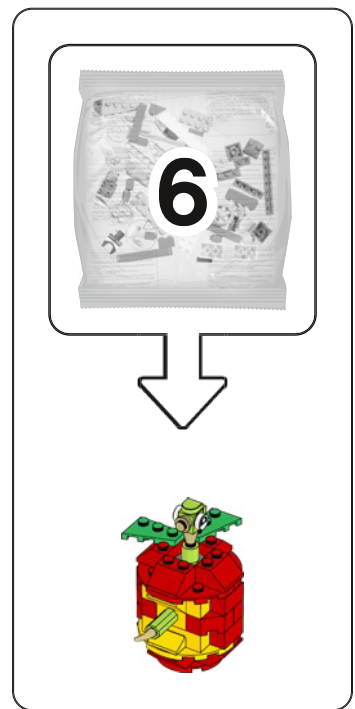

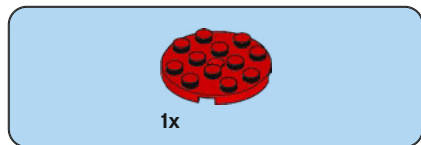

1

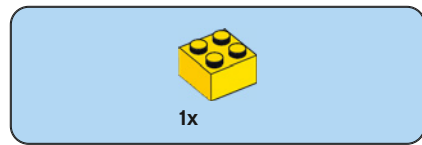
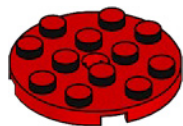

2

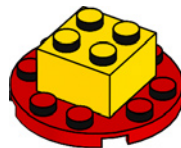



4x

3

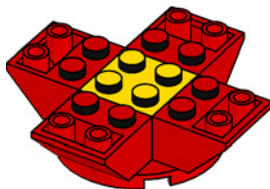

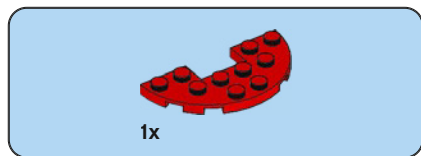

4

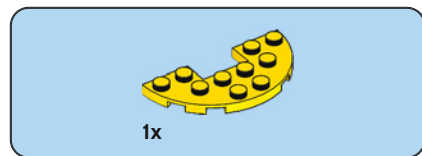
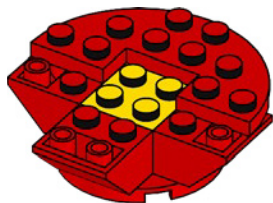

5

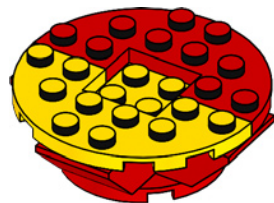



1x

6

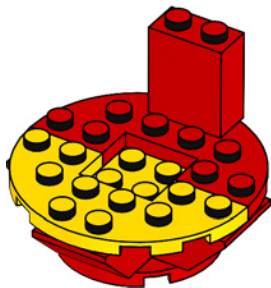

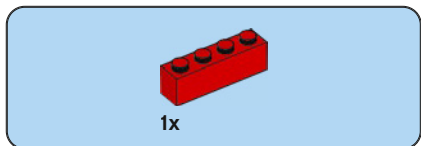

7

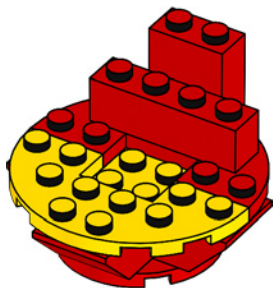

8

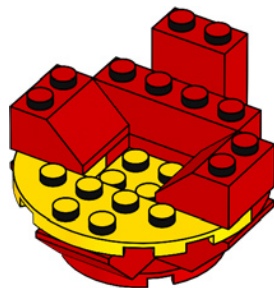

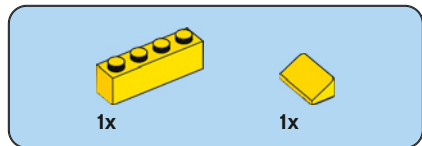

9

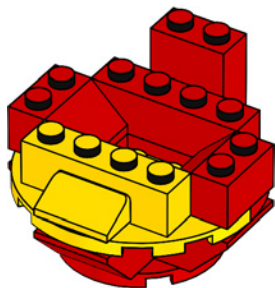



2x

10

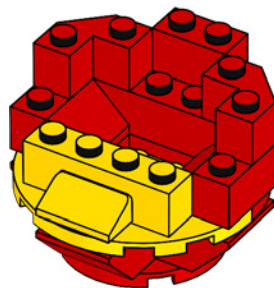

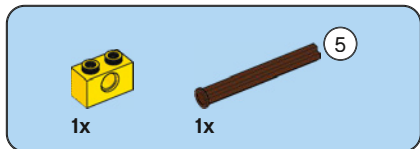
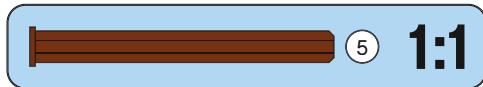
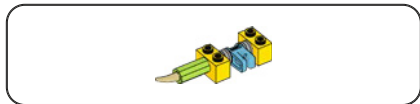

11

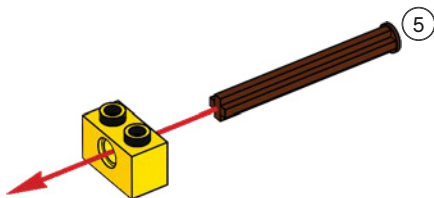



1x

12

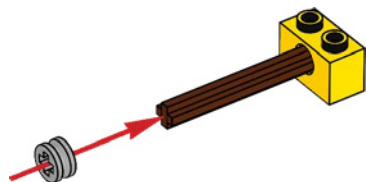

1x



1x

13

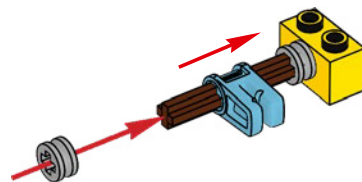



1x



1x

14

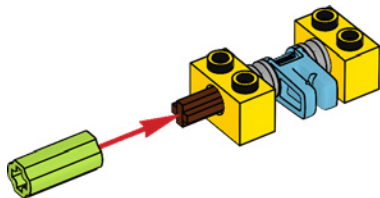



15

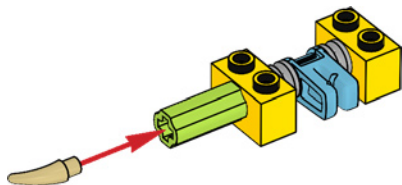

16

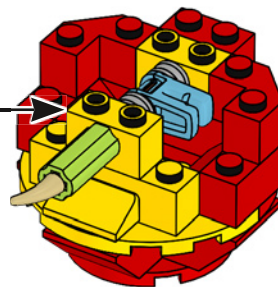



2x

17

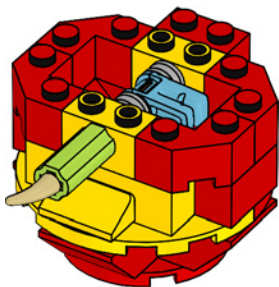



2x

18

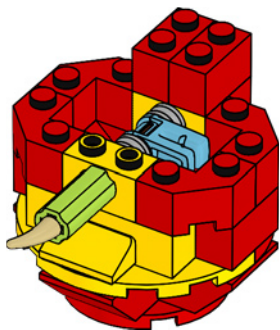

2x

19

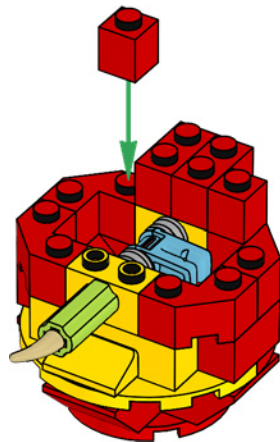



2x

20

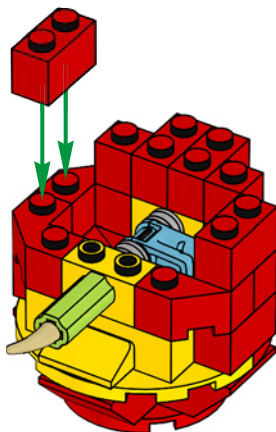



1x

21

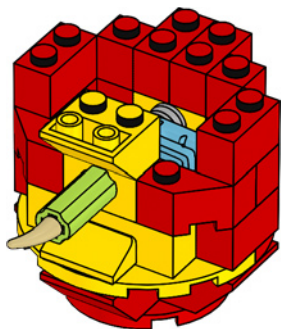

2x

22

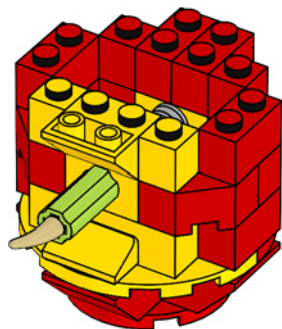

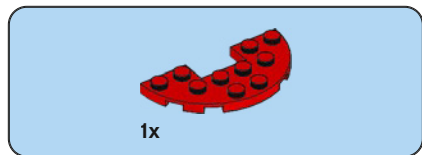

23

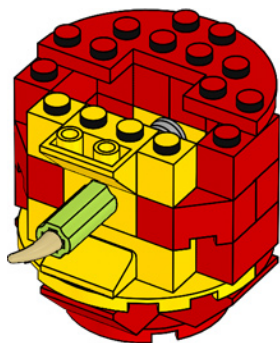

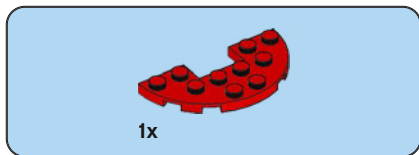

24

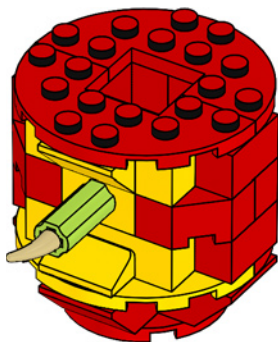

25

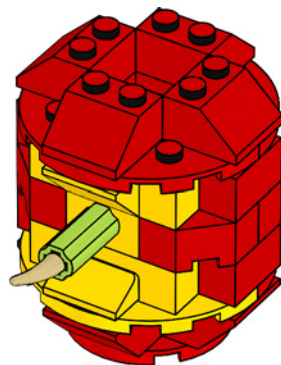



1x



1x

26

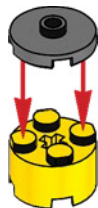



1x



1x

27

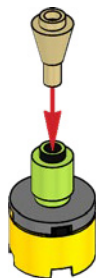

1x

28



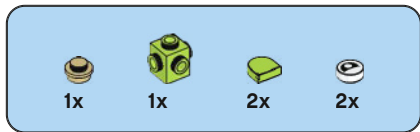

29

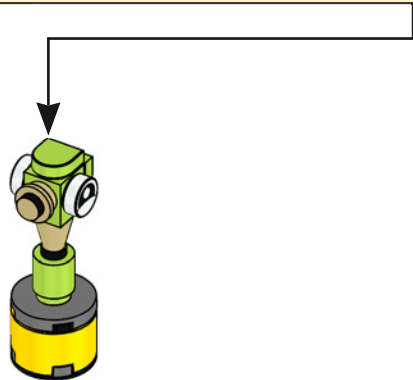
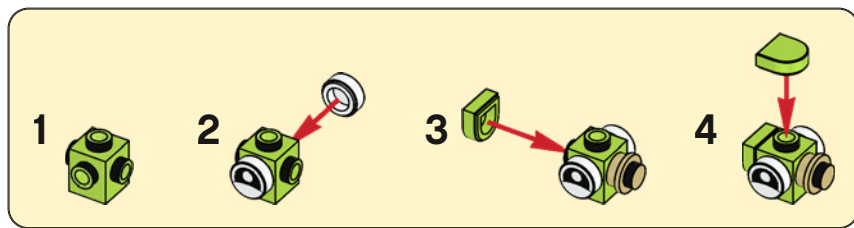

30

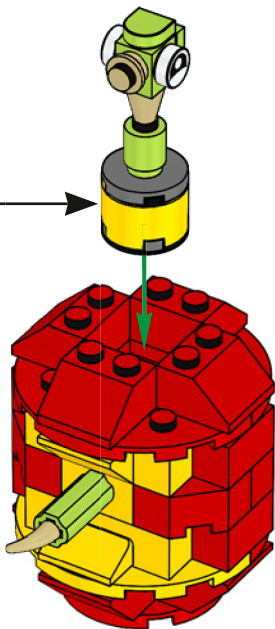

31

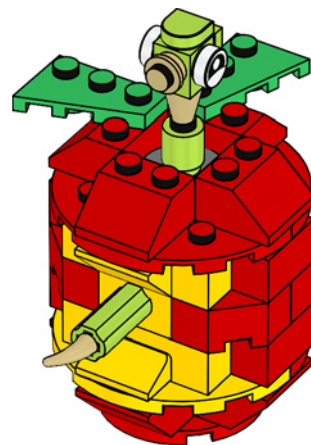
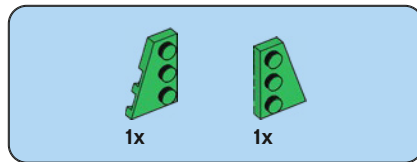

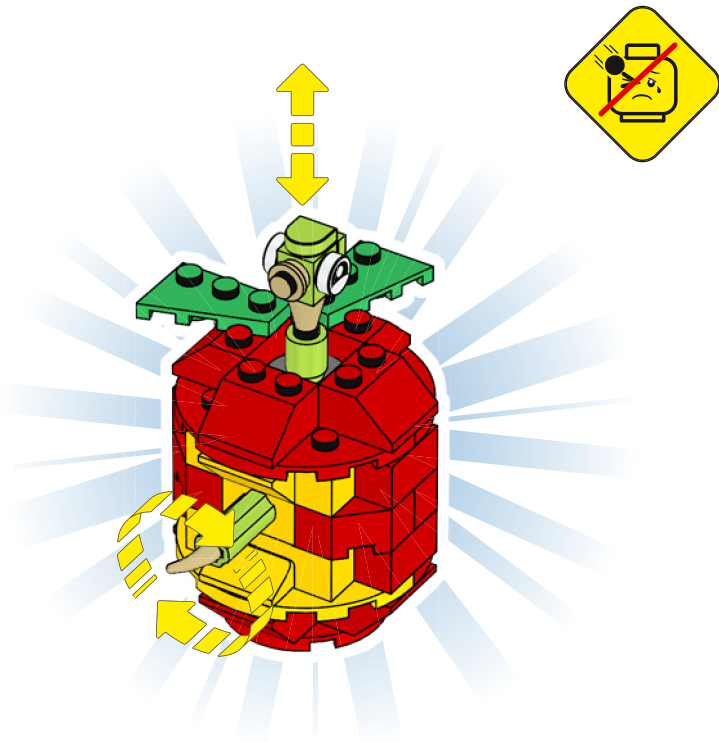



CLASSIC



What fun things can you build?
Welche lustigen Sachen kannst du bauen?
Quels objets amusants peux-tu construire ?
Quali cose divertenti sai costruire?
¿Qué cosas divertidas puedes construir?
Que coisas divertidas consegues construir?
Milyen mókás dolgokat tudsz megépíteni?
Kādas interesantas lietas tu uzbūvēsi?
你能拼搭出什么有趣的模型呢?





CLASSIC



11017



11015



11018

