



Friends

42606



WARNING: CHOKING HAZARD.
Toy contains small parts and a small ball.
Not for children under 3 years.



Q LEGO® Builder



Get excited about our new packaging!

We're switching from plastic to paper-based packaging. That's why you might find a mix of paper and plastic in our boxes!

Nos nouveaux emballages vous emballeront !

Nous passons des emballages en plastique aux emballages à base de papier. C'est pourquoi vous pourriez trouver un mélange de papier et de plastique dans nos boîtes !

¡Te presentamos nuestros nuevos empaques!

Estamos sustituyendo las bolsas de plástico por bolsas con base de papel. ¡Por eso, puedes encontrar una mezcla de papel y de plástico en nuestras cajas!

[LEGO.com/sustainable-packaging](https://www.lego.com/sustainable-packaging)

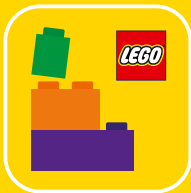

Q LEGO® Builder

BUILDER



Apple and the Apple logo are trademarks of Apple Inc., registered in the U.S. and other countries and regions. App Store is a service mark of Apple Inc. Google Play and the Google Play logo are trademarks of Google LLC. Tencent and the Tencent logo are trademarks of Tencent Inc.

Q LEGO.com/devicecheck

EN Ask parents' permission before going online | **DE** Eltern um Erlaubnis bitten, bevor du online gehst | **FR** Demande l'autorisation d'un parent avant d'aller en ligne | **IT** Chiedi il permesso ai tuoi genitori prima di andare online | **ES** Pídeles permiso a tus papás antes de conectarte a Internet | **PT** pede autorização aos pais antes de acederes online | **ZH** 上网前应先征得父母的同意 | **PL** Poproś rodziców o zgodę, zanim wejdiesz do Internetu | **CS** Než půjdeš na internet, požádej rodiče o svolení | **SK** Skôr než pôjdeš na internet, vypýtaj si povolenie od rodičov | **HU** Kérj szülői engedélyt, mielőtt online csatlakoznál! | **RO** Cere permisiunea părinților înainte de a te conecta online | **BG** Поискайте разрешение от родител, преди да влезете онлайн | **LV** Pirms došanās tiešsaistē palūdz atļauju vecākiem | **ET** Enne Interneti kasutamist küsi vanematelt luba | **LT** Prieš prisijungdami prie interneto, atsiklauskite tėvų





AVERTISSEMENT : RISQUE D'ÉTOUFFEMENT.

Le jouet contient des petites pièces ainsi qu'une petite boule.
Il ne convient pas aux enfants de moins de 3 ans.



ADVERTENCIA: PELIGRO DE ASFIXIA.

Juguete que contiene partes pequeñas y una pelota pequeña.
No recomendado para niños menores de 3 años.

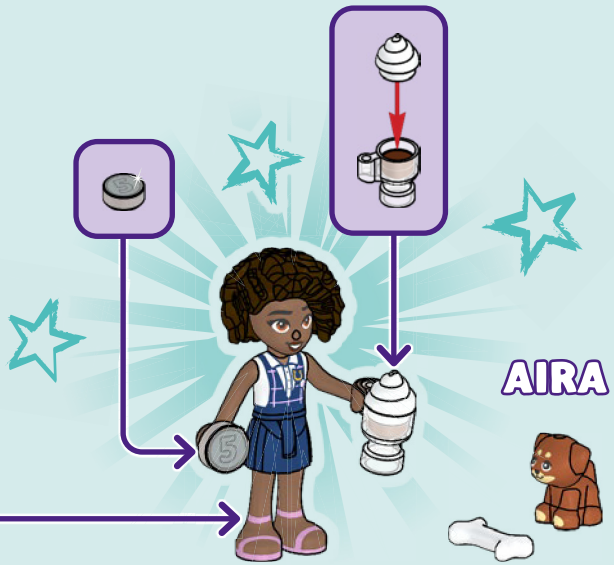

AIRA



ALIYA



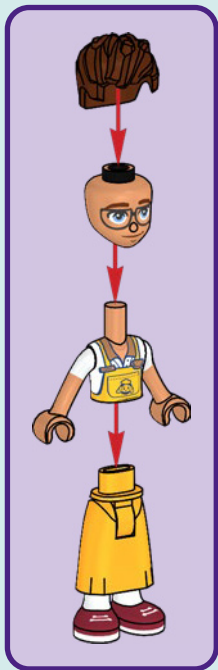

JULES





1x



1x



1x

1

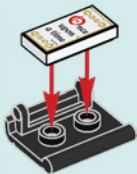

2



3



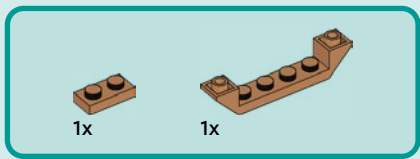
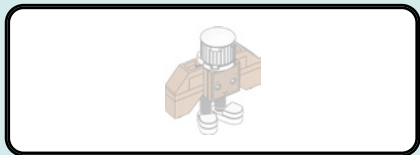

1

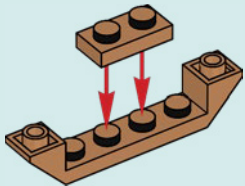



2x

2

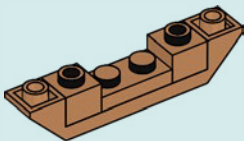

10



1x

3

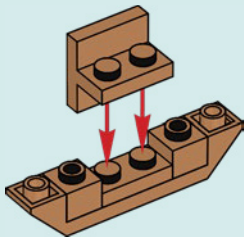

1x

4

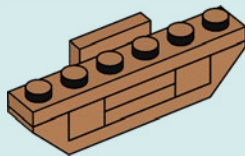



2x



2x

5

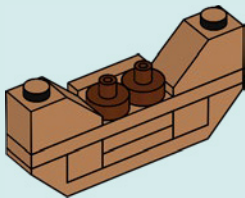



2x



2x



2x

6

1



2



2x

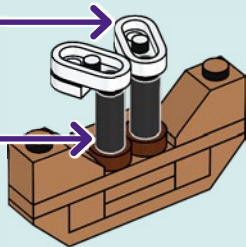



7

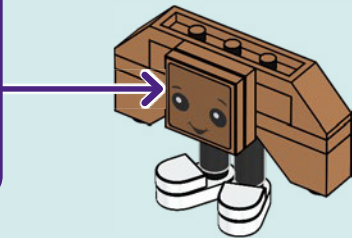
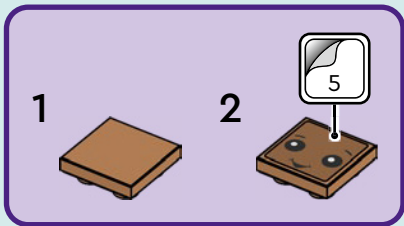
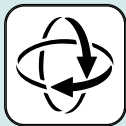

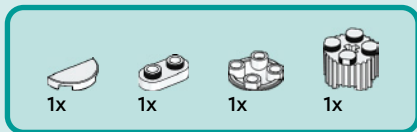

8

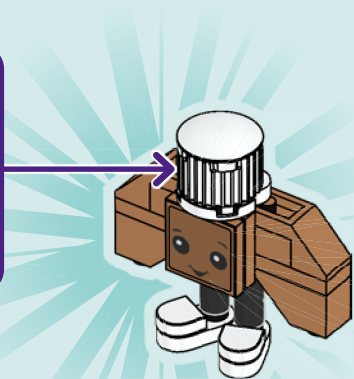
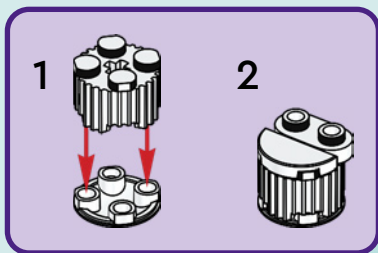

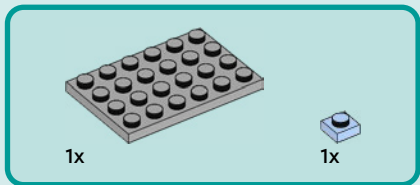

1

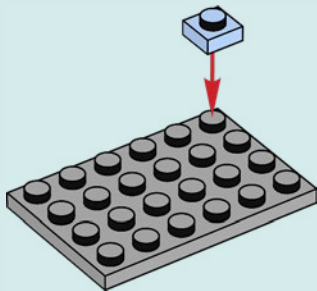

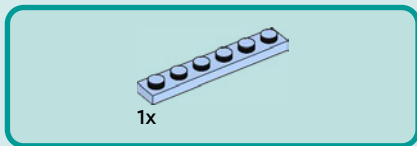

2

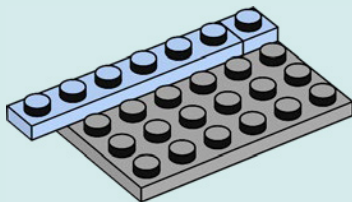



1x

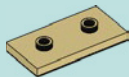

1x

3

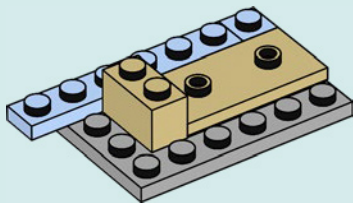



1x

4

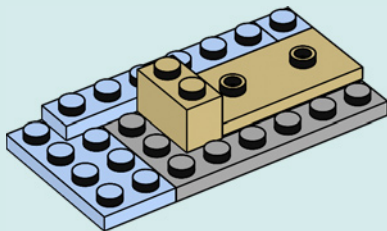



1x

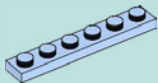

1x

5

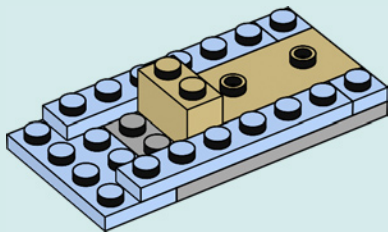



1x



1x

6

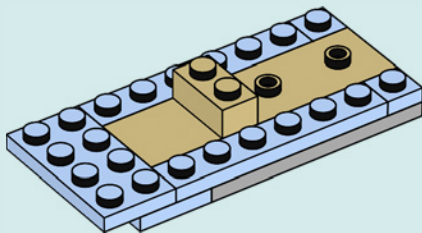

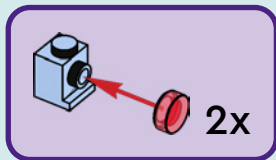
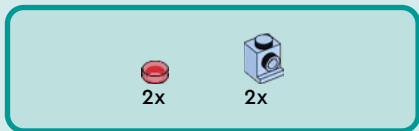

7

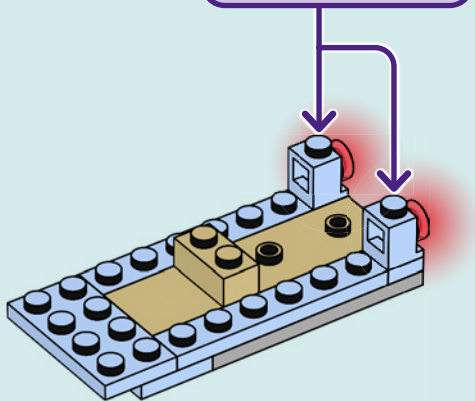



4x

8

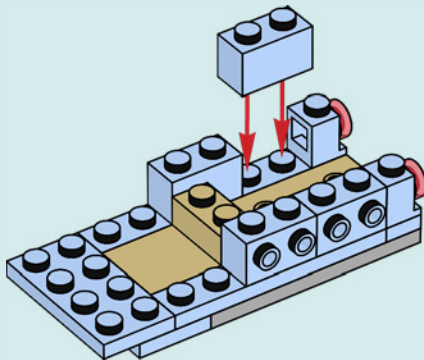

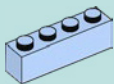

2x

9

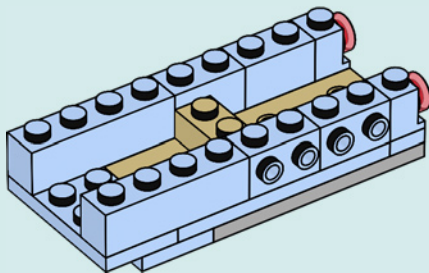



2x

10

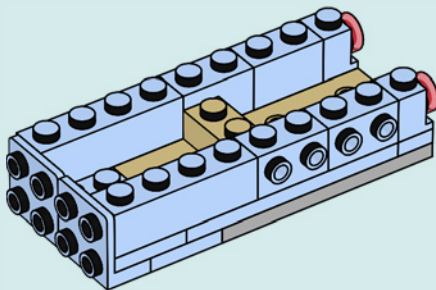



2x

11

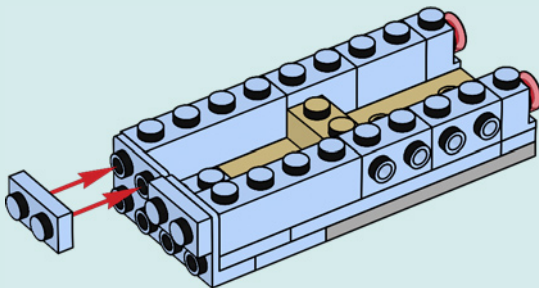



2x

12

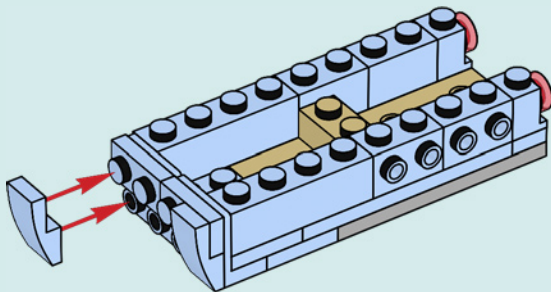



1x

13

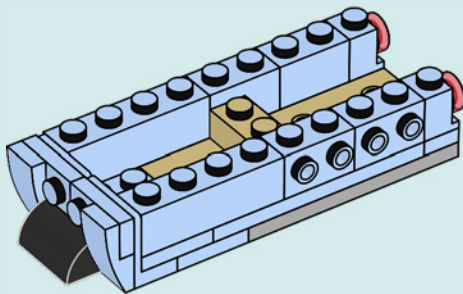



1x



1x

14

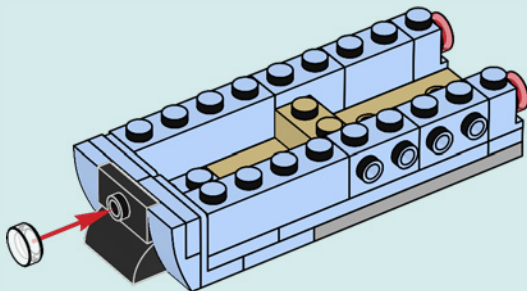

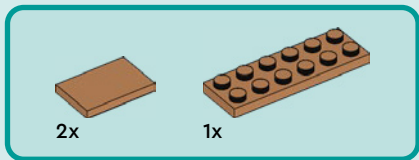

15

1

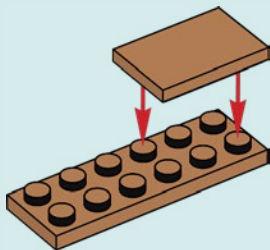

2

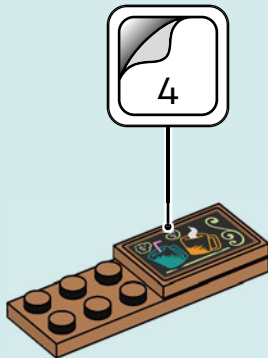

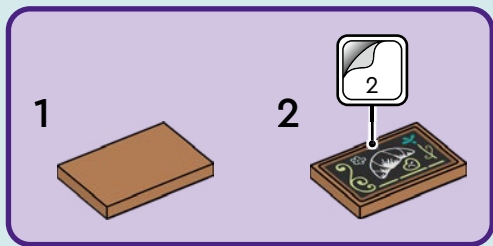

3

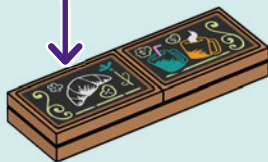

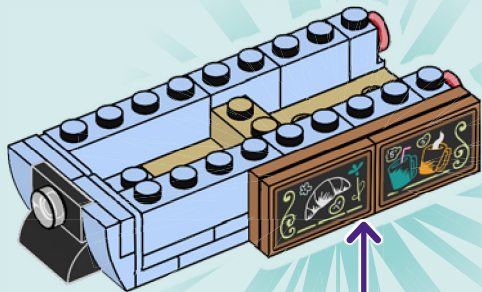

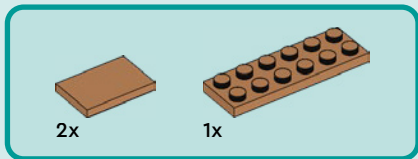

16

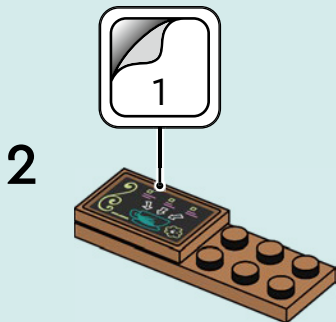
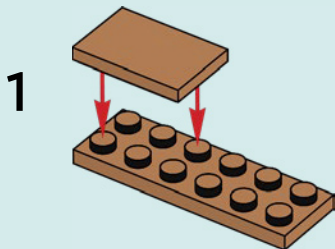

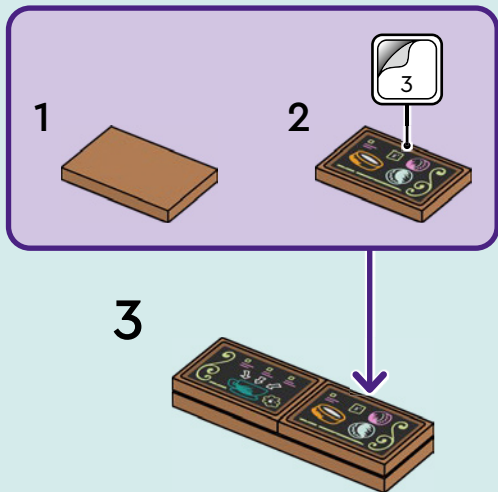

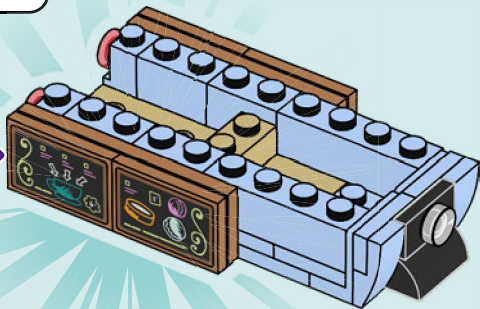



1x



4x

17

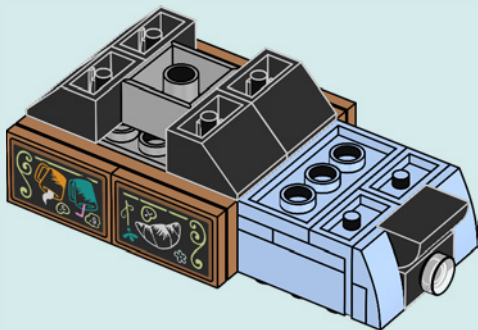



1x



1x

18

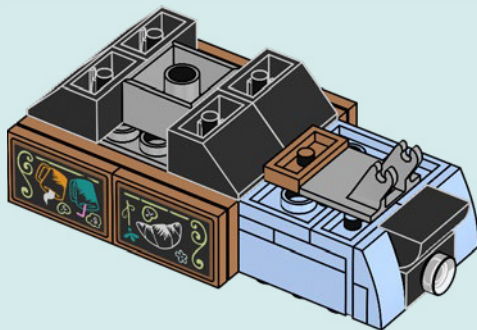



1x

19

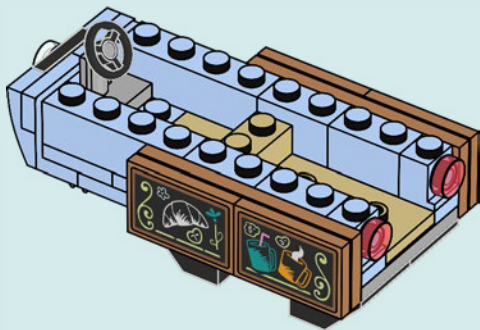
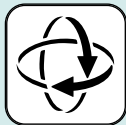

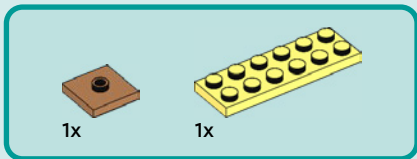

20

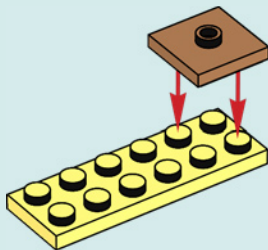



1x



1x

21

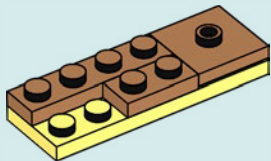

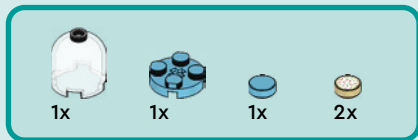

22

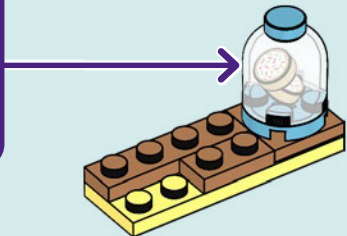
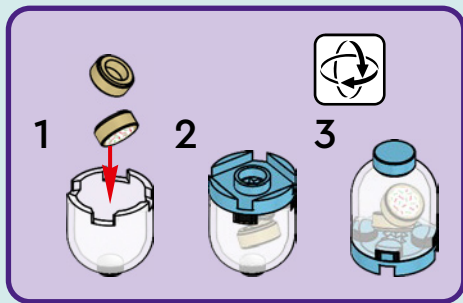



1x



1x

23

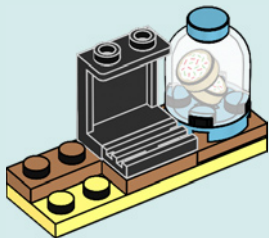



1x



2x

24

1



2

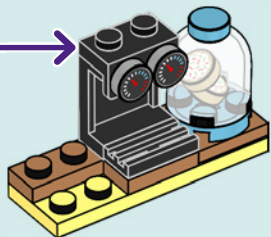



2x



1x

25

1



2

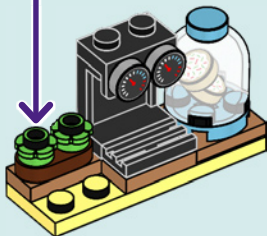



1x

26

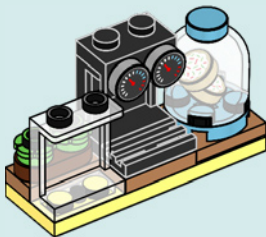

27





1x

28

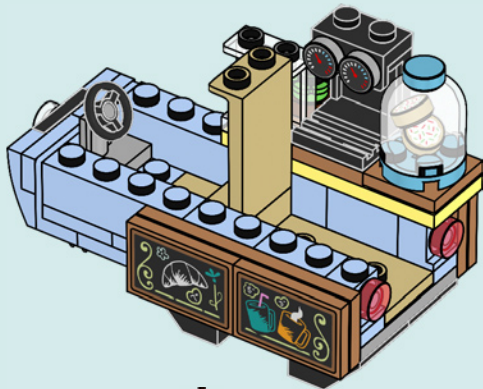

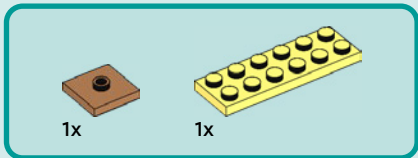

29

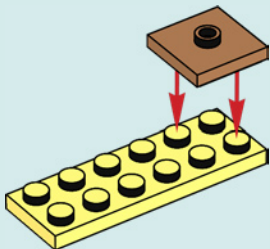



1x



1x

30

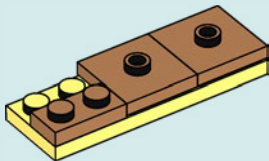

1x



1x



1x

31

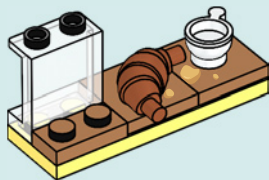



1x



1x



1x



1x

32

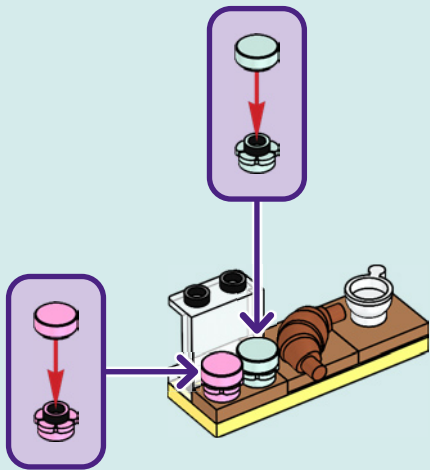

33





1x

34





2x

35



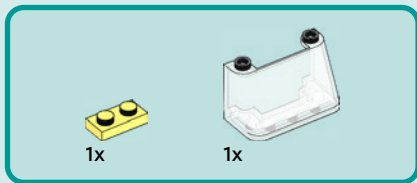

36

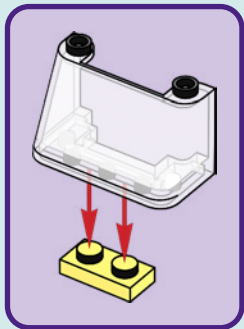

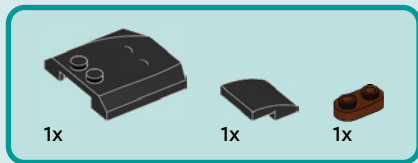

37

1

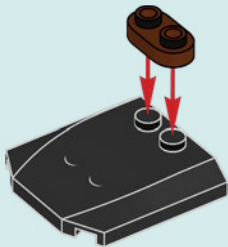

2

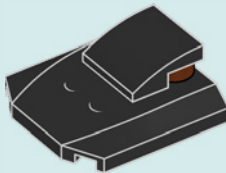

3

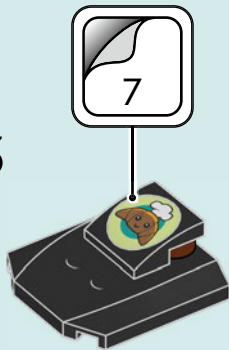

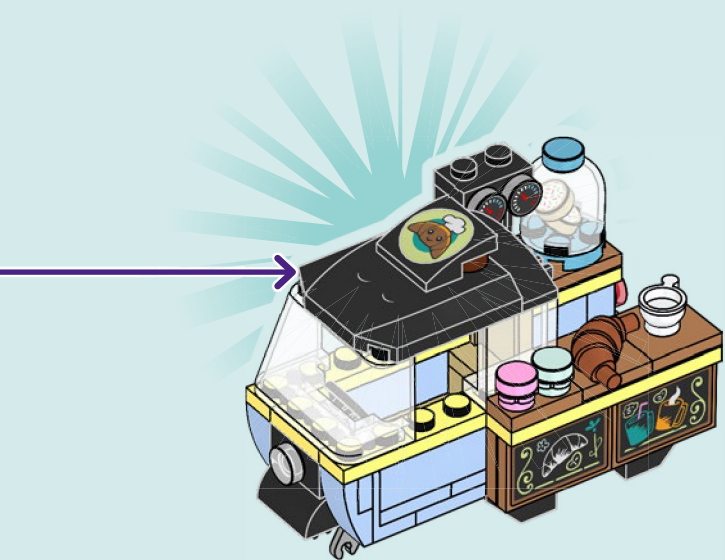



1x

38

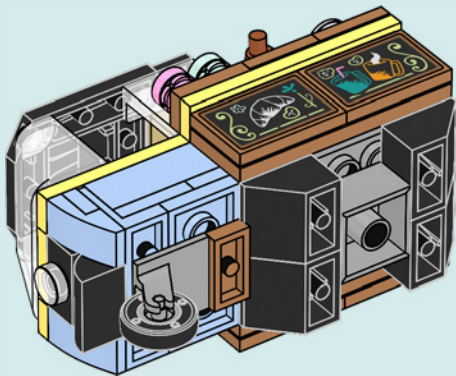
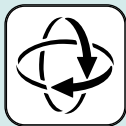

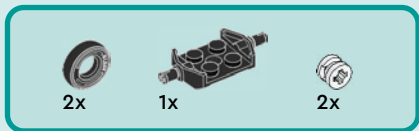

39

1

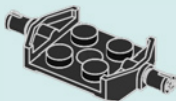

2

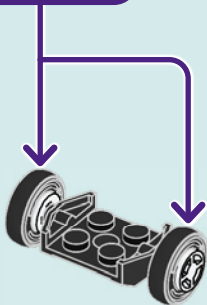

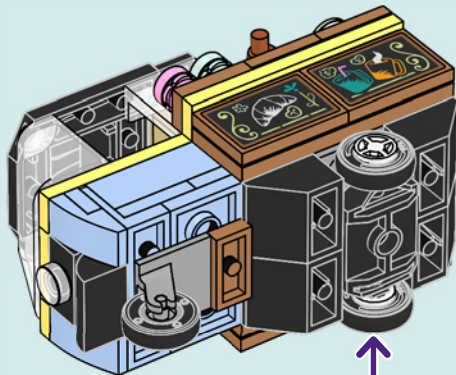





LEGO

Friends

NOVA

OLLY

ALIYA

PAISLEY

LIANN

LEO

AUTUMN

ZAC



LEGO

Friends



LEGO

Friends



REGARDEZ
LA SÉRIE
EN LIGNE

MIRA
LA SÉRIE
EN INTERNET

WATCH
SERIES
ONLINE





Rebuild
the
world™



 1x 6438901	 1x 6360202	 1x 6465572	 1x 241226	 1x 4613153	 2x 6253231	 1x 6443720
 2x 6250591	 2x 6361753	 2x 6290456	 1x 4593678	 1x 6387246	 1x 6253681	 2x 6248944
 2x 6194809	 1x 4109995	 1x 6315573	 1x 6092585	 1x 4191191	 2x 6258607	 2x 6329581
 1x 6235083	 1x 6300317	 1x 6285598	 1x 6275732	 2x 6206150	 1x 6422987	 1x 4211387
 3x 6210272	 1x 4185177	 1x 6283610	 1x 6016172	 1x 6416470	 1x 6466782	 1x 6321198
 1x 6400114	 1x 6294227	 2x 4516843	 4x 6425507	 1x 6424035	 2x 6186673	 1x 4211404
 1x 4650644	 1x 6466207	 1x 4226995	 1x 6053077	 1x 6274738	 1x 6454153	
 1x 4278271				 1x 6286876		
 1x 6157985						



2x
6184484



2x
6387434



4x
6361990



2x
6362254



2x
6335524



2x
6372222



2x
6132418



2x
6287903

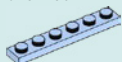

2x
6361985



1x
6212501



1x
6284587



1x
6201647



2x
6248756



2x
6175294



1x
6409768



2x
6383946



4x
6218360



2x
6058135



1x
6313599



3x
6102994



1x
6313601



1x
6167700



4x
6187006



1x
6295464



1x
6466240



2x
6313600



1x
6251854



1x
6322818



1x
6322819



1x
6109752



1x
6329604



1x
6416663



1x
6422985



LEGO.com/service

YOU COULD

WIN



Scan this QR code or go to
LEGO.COM/PRODUCTFEEDBACK and give us
your short feedback about this LEGO® set
for a chance to win a cool LEGO prize.

Terms and Conditions apply*

EN: YOU COULD WIN. Terms and Conditions apply* **DE: Du könntest GEWINNEN.** Es gelten die Teilnahmebedingungen* **FR: Tu pourrais GAGNER.** Des conditions s'appliquent* **IT: Potresti VINCERE tu.** Termini e condizioni sono applicabili* **ES: Puedes GANAR.** Aplican términos y condiciones* **PT: Poderá GANHAR.** Aplicam-se termos e condições* **ZH: 轻松获奖.** 条款和条件适用* **PL: Szansa na WYGRANĄ.** Obowiązują warunki korzystania* **CS: Máte šanci VYHRÁT.** Platí všeobecné smluvní podmínky* **SK: Máte šancu VYHRÁT.** Platia všeobecné zmluvné podmienky* **HU: TE IS NYERHETSZ.** Felhasználási feltételek érvényesek* **RO: Ai putea CÂȘTIGA.** Se aplică termenii și condiții* **BG: Можете да СПЕЧЕЛИТЕ.** Има определени правила и условия* **LV: Tu vari LAIMĒT.** Ir spēkā noteikumi un nosacījumi.* **ET: Sul on võimalus VÕITA.** Kehtivad tingimused* **LT: Jūs galite LAIMĖTI.** Taikomos sąlygos*

*[LEGO.com/productfeedback-terms](https://www.lego.com/productfeedback-terms)

LEGO, the LEGO logo and the FRIENDS logo are trademarks of the/son des marques de commerce du/son marcas registradas de LEGO Group. ©2024 The LEGO Group.

6493649