

Q LEGO® Builder

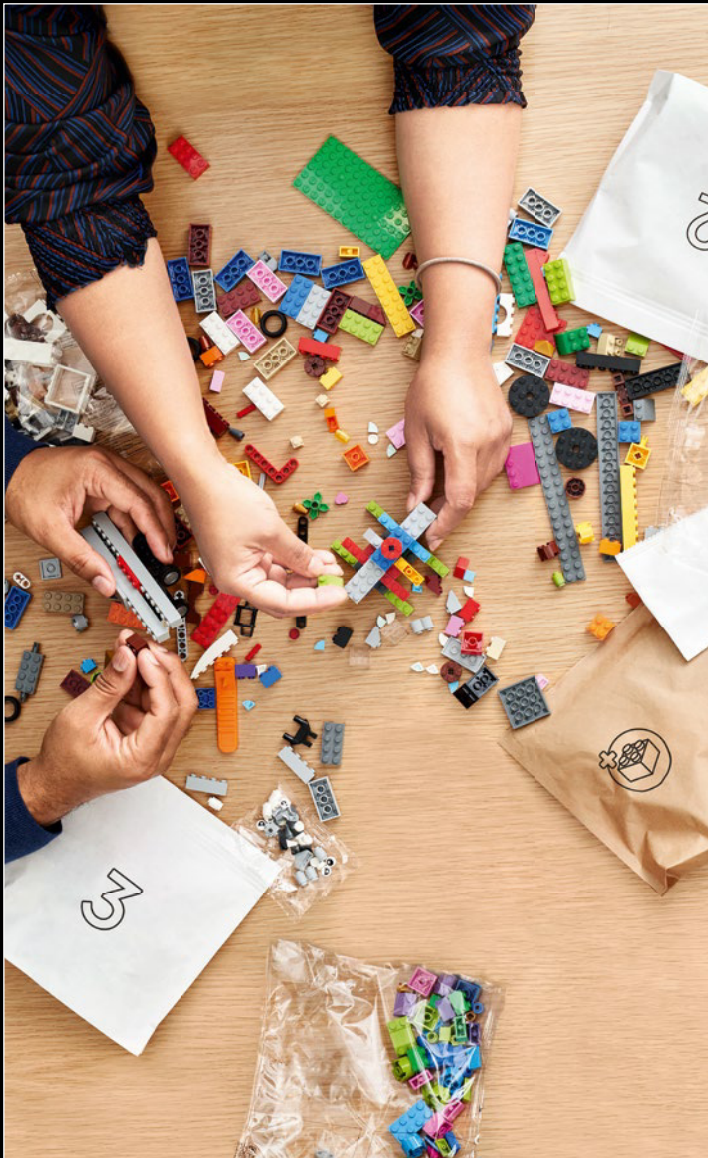

Booklet available in English on
Livret disponible en français sur
Folleto disponible en español en



WE'RE MAKING OUR PACKAGING MORE SUSTAINABLE

We're transitioning from single-use plastic to paper-based packaging. As we progress, you may find a mix of paper and plastic in our boxes.

NOUS RENDONS NOS EMBALLAGES PLUS DURABLES

Nous passons des emballages en plastique à usage unique aux emballages à base de papier. Durant la transition, vous pourriez trouver un mélange de papier et de plastique dans nos boîtes.

QUEREMOS HACER MÁS SUSTENTABLES NUESTROS MATERIALES DE EMBALAJE

Estamos cambiando las bolsas de plástico desechables por bolsas con base de papel. Conforme avanzamos en este propósito, puedes encontrar una mezcla de papel y de plástico en nuestras cajas.

LEGO.com/sustainable-packaging



BUiLDER

Download on the
App Store

GET IT ON
Google Play

 **腾讯应用宝**
安卓应用商店

Apple and the Apple logo are trademarks of Apple Inc., registered in the U.S. and other countries and regions. App Store is a service mark of Apple Inc. Google Play and the Google Play logo are trademarks of Google LLC. Tencent and the Tencent logo are trademarks of Tencent Inc.

 LEGO.com/devicecheck

 **LEGO® Builder**

Meet the fan designer

Marc Corfmat (LEGO® Ideas name Minibrick Productions) is a mechanical engineering student from California. When he's not busy studying, he loves LEGO building, traveling and playing video games with friends.

"LEGO sets have always been a part of my life. I actually got the idea for the Polaroid model while on vacation in La Rochelle, France, where my siblings and I spent most of our childhood summers at our grandparents' house. My brother Nicolas and I would go buy LEGO sets at the local toy store and play with them non-stop for days.

My friends and family played a big role in inspiring this model. My sister and many of my friends love to decorate their walls with instant photos. Additionally, I've always loved the design of the Polaroid OneStep SX-70. It's incredibly iconic and still referenced everywhere. I am extremely happy that the final model has

kept the functionality for taking pictures. It's such a great play feature, and I love that my sister and the La Rochelle harbor are featured in one of the photographs in this set. I hope builders will find ways of expressing their own creativity with the model. Thank you to everyone who supported this project!"

"My biggest hobby is definitely designing custom LEGO models."

Marc's original model of the Polaroid OneStep SX-70

Modèle original de Marc pour le Polaroid OneStep SX-70

Modelo original de Marc de la Polaroid OneStep SX-70



Rencontre avec le concepteur amateur

Marc Corfmat (nom LEGO® Ideas : Minibrick Productions) est un étudiant en génie mécanique vivant en Californie. Quand il n'est pas occupé à étudier, il aime construire des LEGO, voyager et jouer à des jeux vidéo avec ses amis.

« Les ensembles LEGO ont toujours fait partie de ma vie. En fait, j'ai eu l'idée du modèle Polaroid pendant mes vacances à La Rochelle, en France, où mes frères et sœurs et moi avons passé la plupart de nos étés d'enfance chez nos grands-parents. Mon frère Nicolas et moi allions acheter des ensembles LEGO au magasin de jouets local et jouions avec eux sans arrêt pendant des jours.

Mes amis et ma famille ont joué un grand rôle dans l'inspiration de ce modèle. Ma sœur et plusieurs de mes amis adorent décorer leurs murs avec des photos instantanées. En plus, j'ai toujours aimé le style du Polaroid OneStep SX-70. C'est un style très emblématique dont l'influence est visible partout. Je suis extrêmement heureux que le modèle final ait conservé la fonctionnalité permettant de prendre des photos. C'est une excellente fonctionnalité de jeu, et j'adore que ma sœur et le port de La Rochelle figurent sur l'une des photographies de cet ensemble. J'espère que les constructeurs trouveront des moyens d'exprimer leur propre créativité avec le modèle. Merci à tous ceux et celles qui ont soutenu ce projet! »

« Mon plus grand passe-temps est, sans aucun doute, de concevoir des modèles LEGO personnalisés. »

Conoce al fan diseñador

Marc Corfmat (conocido en LEGO® Ideas como Minibrick Productions) es un estudiante de ingeniería mecánica que reside en California. Cuando no está ocupado estudiando, le encanta construir con LEGO, viajar y jugar videojuegos con sus amigos.

“Los sets LEGO siempre han formado parte de mi vida. De hecho, la idea del modelo de la Polaroid la tuve durante unas vacaciones en La Rochelle (Francia), donde mis hermanos y yo pasamos la mayoría de los veranos de nuestra infancia en casa de nuestros abuelos. Mi hermano Nicolas y yo teníamos la costumbre de ir a comprar sets LEGO a la juguetería local y jugar con ellos sin parar durante días.

Mis amigos y familiares desempeñaron un importante papel en la inspiración de este modelo. A mi hermana y a muchos de mis amigos les encanta decorar las paredes de sus casas con fotos instantáneas. Además, siempre me ha parecido increíble el diseño de la Polaroid OneStep SX-70. Las incontables referencias a ella que aún hoy en día encontramos

“El más grande de mis pasatiempos es, sin lugar a dudas, diseñar modelos LEGO personalizados”.

por todas partes ponen de manifiesto su vigencia como un ícono en la cultura popular. Me hace muy feliz que el modelo final haya conservado la funcionalidad de tomar fotos. Es fantástica como

característica complementaria para jugar, y me encanta que mi hermana y el puerto de La Rochelle aparezcan en una de las fotos del set. Espero que los constructores encuentren formas de expresar su propia creatividad con el modelo. Agradezco a todos los que apoyaron este proyecto”.

The legacy of the Polaroid Corporation

The thought of waiting for days or even weeks from the time you snap a picture until you can see it is either completely foreign to some, or a faint memory to others. Today, we can share photos with our loved ones or the entire world in a matter of seconds. But instant digital photography actually descends from a long line of technology and innovations pioneered by one of the great visionaries of the 20th century, Edwin H. Land (1909-1991).

A curious scientist and engineer by nature, Land began working on his first inventions when he was only 13 years old and would go on to patent over 500 inventions. Among the first and most famous of them were his affordable, synthetic polarized materials developed to reduce glare in camera and sunglass lenses. In 1937, Land and his partner George Wheelwright named their newly-incorporated business after this invention – the Polaroid Corporation. In 1943, while on holiday with his family, Land's young daughter asked to see a photo he had just taken of her. Land was immediately intrigued – why wouldn't it be possible to make a photograph instantly available?



“Don't do anything that someone else can do. Don't undertake a project unless it is manifestly important and nearly impossible.”

– Edwin Land, inventor, entrepreneur, artist and scientist

« Ne faites rien que quelqu'un d'autre puisse faire. N'entreprenez pas un projet à moins qu'il ne soit manifestement important et presque impossible. »

– Edwin Land, inventeur, entrepreneur, artiste et scientifique

“No hagas nada que otra persona pueda hacer. No emprendas un proyecto a menos que se trate de algo indiscutiblemente importante y prácticamente imposible de lograr”

Edwin Land, inventor, empresario, artista y científico

L'héritage de la société Polaroid

L'idée d'attendre des jours, voire des semaines, entre le moment où vous prenez une photo et celle où vous pouvez la voir est soit complètement étrangère à certains, soit un lointain souvenir pour d'autres. Aujourd'hui, nous pouvons partager des photos avec nos proches ou avec le monde entier en quelques secondes. Mais la photographie numérique instantanée descend en réalité d'une longue lignée de technologies et d'innovations mises au point par l'un des grands visionnaires du 20^e siècle, Edwin H. Land (1909-1991).

Scientifique et ingénieur curieux de nature, Land a commencé à travailler sur ses premières inventions alors qu'il était âgé de seulement 13 ans. Durant sa carrière, il a breveté plus de 500 inventions. Au nombre de ses premières inventions les plus célèbres figurent des matériaux polarisés synthétiques abordables créés pour réduire le reflet des objectifs d'appareil photo et des lunettes de soleil. En 1937, Land et son partenaire George Wheelwright nomment leur entreprise nouvellement constituée d'après cette invention : la Polaroid Corporation. En 1943, alors qu'il était en vacances avec sa famille, la fille de Land a demandé à voir une photo qu'il venait de prendre d'elle. Land a immédiatement été intrigué; pourquoi ne serait-il pas possible de rendre une photo disponible instantanément?

El legado de Polaroid Corporation

La idea de esperar días o incluso semanas desde que tomas una foto hasta que puedes verla es totalmente ajena a algunos y, para otros, se trata de un recuerdo cada vez más vago. Hoy podemos compartir fotos con nuestros seres queridos o con el mundo entero en cuestión de segundos. Pero, en realidad, la fotografía digital instantánea descende de una larga serie de tecnologías e innovaciones de las que fue pionero uno de los grandes visionarios del siglo XX: Edwin H. Land (1909-1991).

Dueño de una excepcional curiosidad natural, además de científico e ingeniero de profesión, Land empezó a trabajar en sus primeros inventos cuando tenía solo 13 años y en su lista de patentes figuran más de 500 invenciones. Entre las primeras y más famosas de ellas se encuentra el material polarizante sintético de bajo costo que desarrolló con el fin de reducir los efectos del deslumbramiento en las cámaras fotográficas y los lentes de sol. En 1937, Land y su socio George Wheelwright bautizaron su empresa recién constituida con el nombre de este invento: Polaroid Corporation. En 1943, mientras estaba de vacaciones con su familia, la hija pequeña de Land le pidió ver una foto que acababa de tomarle. Al instante, un intrigante pensamiento asaltó a Land: ¿por qué no sería posible hacer que una foto estuviera disponible inmediatamente después de tomarla?



Beautifully imperfect

Land developed a new technology that allowed developer chemicals to react with the photo paper inside the camera. In 1948, the first Polaroid instant camera, the Land Camera Model 95, was released. The unpredictable nature of the development process in every version of the Polaroid camera, including the OneStep SX-70, always added its own unique life to a photo. Through the decades, Land collaborated with contemporary artists and photographers like Keith Haring and Andy Warhol, who played a big role in developing The Polaroid Collection – an extensive library of iconic Polaroid photographs.



The Polaroid Company dominated the global instant photography market well into the early 1980s. Towards the turn of the century, however, the company struggled to find its footing in the emerging digital era. In 2008, following two bankruptcies, new owners saw the potential in their original founder's values of inspiring change, documenting real life and expressing creative ideas through a tangible medium. They launched The Impossible Project to revive and redefine the future of instant film photography. The initiative, and the newly reconstructed Polaroid B.V., fed right into a desire among new artists, enthusiasts and professionals to experiment with authentic, real-life photography. Now, more than 85 years after his company was founded, Edwin Land's legacy lives on in new camera technology that has been embraced by a flourishing global community of fans and creators.

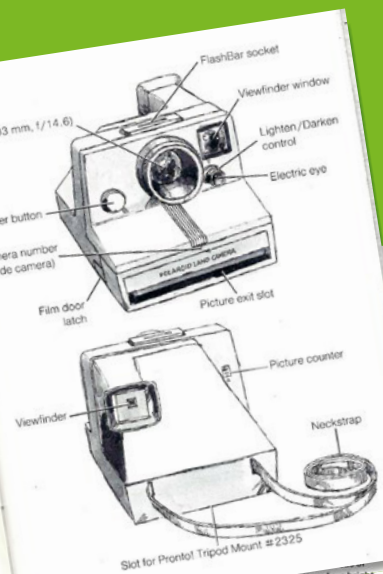

PICTURES OUTDOORS: PEOPLE
In bright daylight, stand so the light falling on the subject comes from behind you or from the side.

But use flash (4-8 ft. only) if your subject is in the shade, is in dim light or has harsh shadows. Also use flash if you must take the picture with the light coming from behind your subject.

OneStep's fill-flash feature will automatically balance the flash with daylight to give you pleasing, well exposed pictures. You will get best results with fill-flash when you are about 6 ft. from your subject.

Rule for success: If in doubt about the light, use flash.



PICTURES OUTDOORS: SCENES
In bright daylight, stand so the sun is behind you or at the side. If the sun is shining into your eyes (and into the camera's electric eye) the scene will be too dark in your picture.

If the light is not bright, rest the camera on a firm support or use a tripod to prevent movement and fuzzy pictures. OneStep can automatically make a time exposure for as long as 1 second.



clothing, toys, etc. Look for pleasing backgrounds — OneStep "sees" them, too.

PICTURES INDOORS
Use flash for all indoor pictures. Stand 4-8 ft. (no more, no less) from your subject. Try to have your subject near a light,



Magnifiquement imparfait

Land a développé une nouvelle technologie grâce à laquelle les produits chimiques de développement réagissent directement avec le papier photo à l'intérieur de l'appareil. En 1948, le premier appareil photo instantané Polaroid, le Land Camera Model 95, a été lancé. La nature imprévisible du processus de développement pour chaque version de l'appareil photo Polaroid, y compris le OneStep SX-70, a toujours produit des photos au caractère unique. Au fil des décennies, Land a collaboré avec divers artistes et photographes contemporains tels que Keith Haring et Andy Warhol, qui ont joué un rôle important dans le développement de la collection Polaroid – une vaste bibliothèque de photographies Polaroid emblématiques.

La société Polaroid a dominé le marché mondial de la photographie instantanée jusqu'au début des années 1980. Vers le tournant du siècle, cependant, l'entreprise a eu du mal à trouver sa place dans l'ère numérique émergente. En 2008, après deux faillites, les nouveaux propriétaires ont su identifier le potentiel inhérent aux valeurs de leur fondateur originel : inspirer le changement, documenter le quotidien et exprimer des idées créatives à travers un support tangible. Ils ont alors lancé le Projet impossible (The Impossible Project) pour raviver la flamme et redéfinir l'avenir de la photographie argentique instantanée. L'initiative, de même que la renaissance de Polaroid B.V., a vite trouvé écho chez les nouveaux artistes, les passionnés et les professionnels avides d'expérimenter avec des photographies authentiques et réelles. Aujourd'hui, plus de 85 ans après la création de son entreprise, l'héritage d'Edwin Land se perpétue à travers une nouvelle technologie d'appareils photo adoptée par une communauté mondiale et croissante de passionnés comme de créateurs.

Bellamente imperfecta

Land desarrolló una nueva tecnología que permitía que los productos químicos utilizados para el revelado reaccionaran con el papel fotográfico en el interior de la cámara. En 1948, salió a la venta la primera cámara instantánea Polaroid, la Land Camera Model 95. La impredecible naturaleza del proceso de revelado de cada una de las versiones de la cámara Polaroid, incluida la OneStep SX-70, siempre añadía una personalidad única a cada foto. A lo largo de las décadas, Land colaboró con artistas y fotógrafos contemporáneos como Keith Haring y Andy Warhol, quienes desempeñaron un importante papel en el desarrollo de The Polaroid Collection, una extensa biblioteca de fotografías icónicas tomadas con cámaras Polaroid.

Polaroid Company dominó el mercado mundial de la fotografía instantánea hasta comienzos de la década de 1980. No obstante, hacia el cambio de siglo, la empresa luchó por encontrar su propio lugar en la emergente era digital. En 2008, luego de dos quiebras, los nuevos propietarios vieron el potencial que había en los valores de su fundador original de inspirar el cambio, documentar la vida real y expresar ideas creativas a través de un medio tangible. Con eso en mente, lanzaron un proyecto dirigido a revivir y redefinir el futuro de la fotografía instantánea con película denominado The Impossible Project. La iniciativa, y la recién reconstruida Polaroid B.V., llamaron la atención de nuevos artistas, entusiastas y profesionales y alimentaron su deseo de experimentar con una de las modalidades más auténticas de la fotografía. Hoy en día, más de 85 años después de la fundación de su empresa, el legado de Edwin Land sigue vivo en una cámara con una novedosa tecnología que ha sido adoptada por una floreciente comunidad mundial de fans y creadores.

From the LEGO® Design Team

“The Polaroid OneStep SX-70 from 1978 is a classic 20th-century design icon. Marc’s submission made us do a double take of ‘Wait, that’s made of LEGO® bricks?’ and we wanted to keep that accuracy in the final model. Being able to ‘take’ a photo with the press of a button is definitely the most satisfying part.

We originally planned to use two stickers for the stripe on the front of the camera, but we worked out some creative building angles to allow the iconic stripes to flow down the front and over the side using LEGO plates. Having a functional viewfinder really adds to the play value of the model. And yes, it may be a model for adults, but I hope you’ll still have fun *playing* with it!”

James May, LEGO® Ideas Model Designer

“One of the challenging parts for me as a Graphic Designer was deciding where to use printed parts or stickers so the model would maintain its iconic look. Photography is a magical way to capture special moments you can share with others or treasure for yourself, and I hope the photo eject function is something that will spark joy in Polaroid fans! The PP foil used in the ‘photographs’ really helped us perfect the look and feel of the original. Inspired by the theme ‘Memories,’ we created images that connect the Polaroid legacy with Marc’s family memories and our LEGO history. And PS: In Europe, the camera was launched as Polaroid 1000, so you can choose between the ‘OneStep’ or ‘1000’ stickers for your model.”

*Matthew Parsons, LEGO® Ideas
Graphic Designer*



LEGO® Ideas designers/
Les concepteurs de LEGO Ideas /
Los diseñadores de LEGO Ideas
James May & Matthew Parsons



Un mot de l'équipe de conception LEGO®

« Le Polaroid OneStep SX-70 de 1978 est une icône emblématique du design du 20^e siècle. Le modèle soumis par Marc nous a sérieusement fait nous demander : “Attendez, c’est vraiment fait de briques LEGO® ?” Pour nous, il était essentiel de garder cette précision dans le modèle final. Pouvoir “prendre” une photo en appuyant sur un bouton est sans aucun doute l’aspect le plus satisfaisant. Il était initialement prévu d’utiliser deux autocollants pour la bande à l’avant de l’appareil photo, mais nous avons trouvé des angles de construction créatifs qui permettent, à l’aide de plaques LEGO, de dérouler les bandes emblématiques à l’avant et sur le côté. Le viseur fonctionnel ajoute vraiment à la valeur de jeu du modèle. Et oui, il s’agit peut-être d’un modèle pour adultes, mais j’espère que vous aurez tout de même beaucoup de plaisir à jouer avec! »

James May, concepteur de modèles LEGO® Ideas

« En tant que graphiste, c’était un grand défi pour moi de choisir où utiliser des pièces imprimées et où utiliser des autocollants pour que le modèle conserve son aspect emblématique. La photographie est un moyen magique de capturer des moments spéciaux que vous pouvez partager avec d’autres ou chérir pour vous-même. J’espère que la fonction d’éjection de photo suscitera la joie chez les passionnés de Polaroid! Le film de polypropylène utilisé pour les “photographies” nous a vraiment aidés à reproduire à la perfection l’aspect et la convivialité de l’original. Inspirés par le thème “Souvenirs”, nous avons créé des images qui relient l’héritage Polaroid aux souvenirs de famille de Marc et à notre histoire LEGO. Et P.-S. : En Europe, l’appareil photo a été lancé sous le nom de Polaroid 1000. Vous pourrez donc choisir entre les autocollants “OneStep” ou “1000” pour votre modèle. »

Matthew Parsons, graphiste LEGO® Ideas

Impresiones del equipo de diseño de LEGO®

“La Polaroid OneStep SX-70 de 1978 es un ícono del diseño clásico del siglo XX. La propuesta de Marc nos hizo pensar dos veces ‘¿De verdad esta cosa está hecha con bricks LEGO®?’, y quisimos mantener esa precisión en el modelo final. Poder *tomar* una foto presionando un botón es, sin duda, la parte más satisfactoria. En un principio, pensamos en utilizar dos calcomanías para la franja de la parte delantera de la cámara, pero, en su lugar, encontramos una solución creativa para recrear con placas LEGO las icónicas líneas que fluyen por la parte delantera y por el lateral. Contar con un visor funcional aumenta significativamente el valor de juego del modelo. Y sí, puede que sea un modelo para adultos, ¡pero espero que eso no sea un obstáculo para que se diviertan *jugando* con él!”

James May, modelista de LEGO® Ideas

“Como diseñador gráfico, uno de los grandes desafíos que enfrenté fue decidir dónde utilizar piezas estampadas y en qué lugares usar calcomanías para que el modelo mantuviera su icónico aspecto. La fotografía es una mágica forma de capturar momentos especiales para compartirlos con los demás o atesorarlos para ti mismo. ¡Espero que la función de expulsión de fotos sea algo que despierte la alegría de los fans de Polaroid! La lámina de polipropileno utilizada en las *fotos* fue muy útil para recrear a la perfección el aspecto y la sensación de la cámara original. Conectándonos con el baúl de los recuerdos, creamos imágenes que vinculan el legado de Polaroid con la trayectoria de la familia de Marc y la historia de LEGO. Antes de despedirme, también me gustaría resaltar que, en Europa, la cámara se lanzó como Polaroid 1000, por lo que tienes la posibilidad de elegir entre las calcomanías con la leyenda ‘OneStep’ y las que dicen ‘1000’ para tu modelo”.

Matthew Parsons, diseñador gráfico de LEGO® Ideas

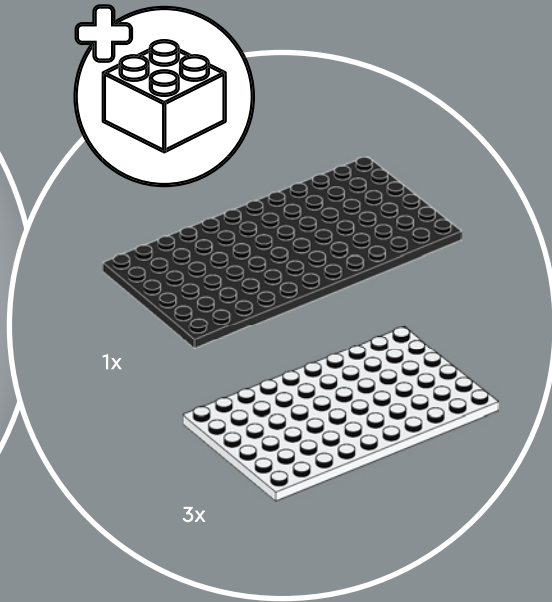
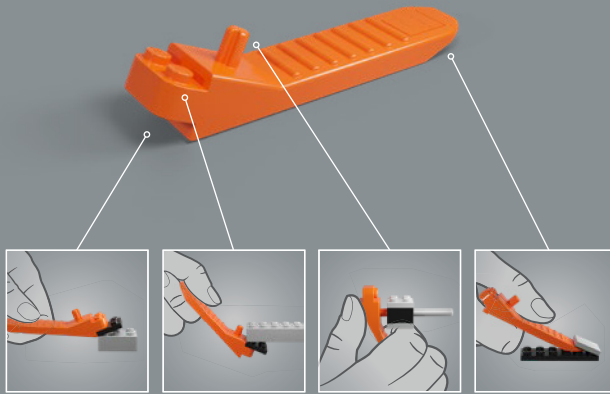

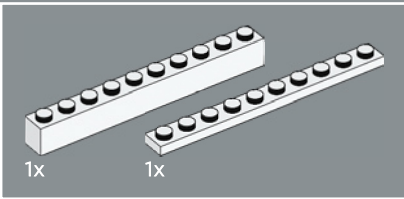
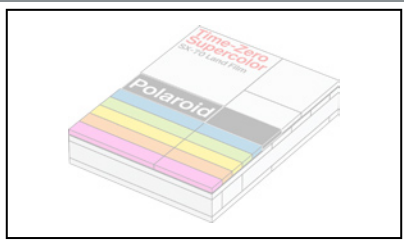

1

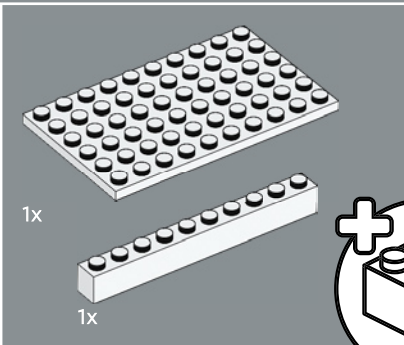
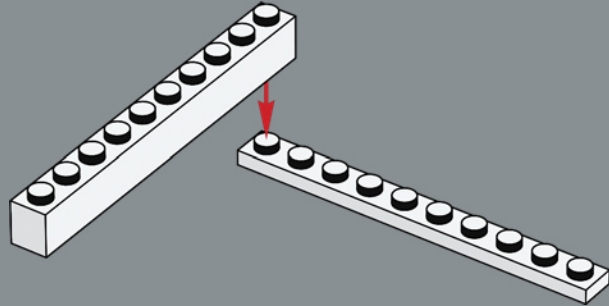

2

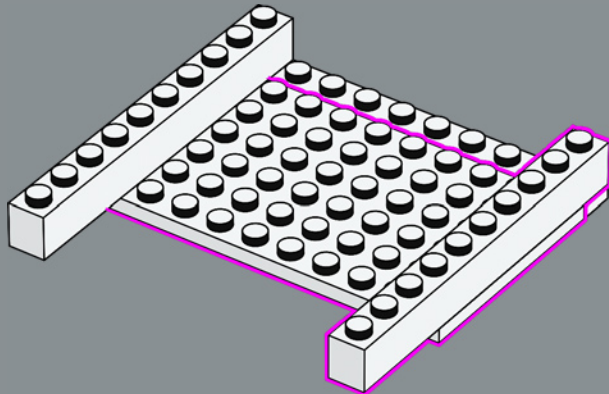

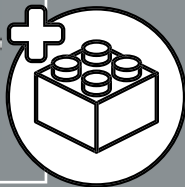
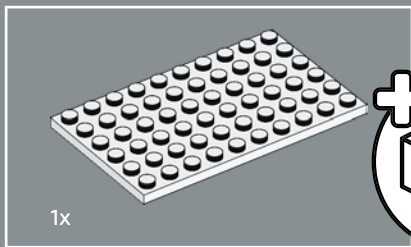

3

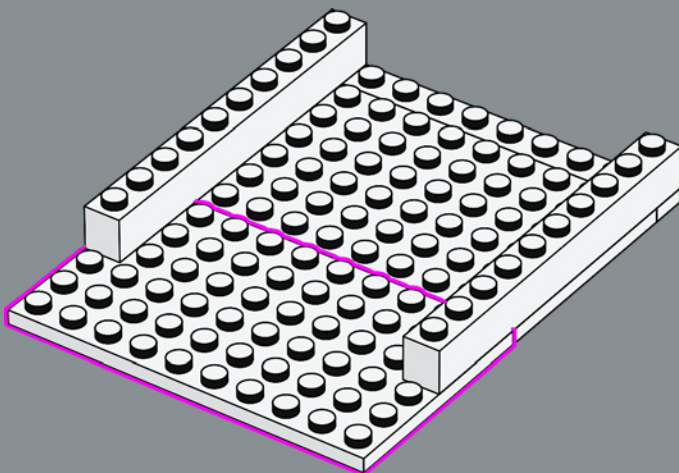

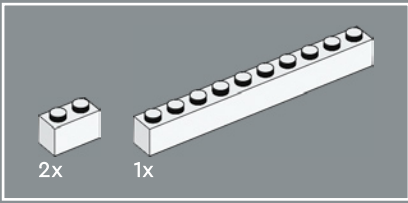

4

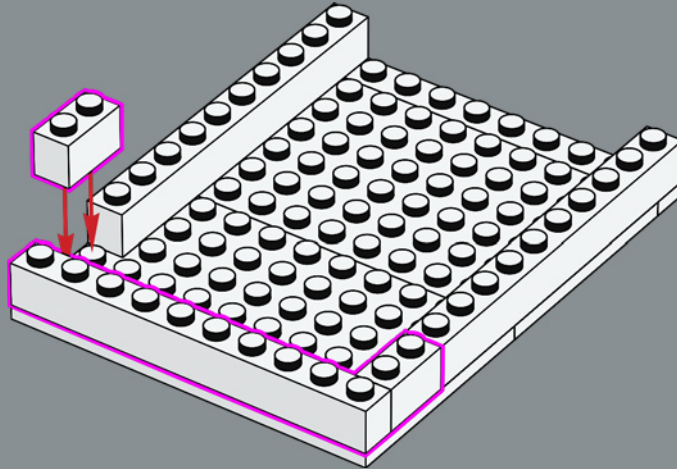

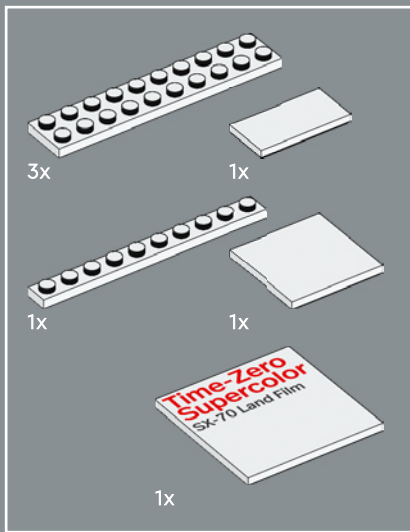

5

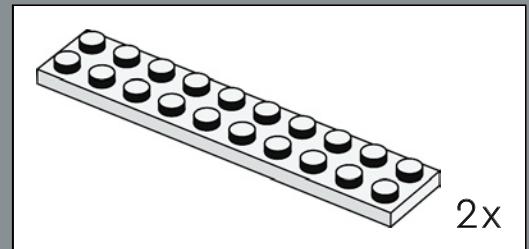
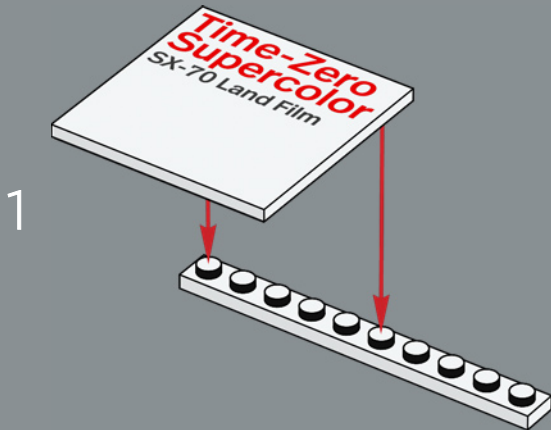

2

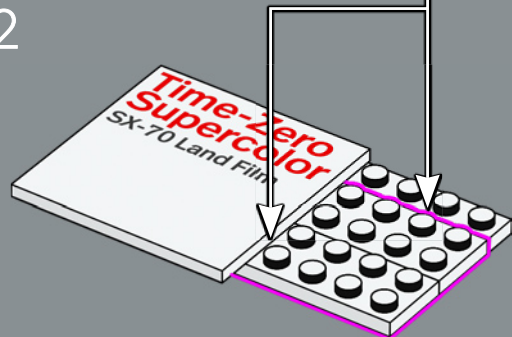

3



4

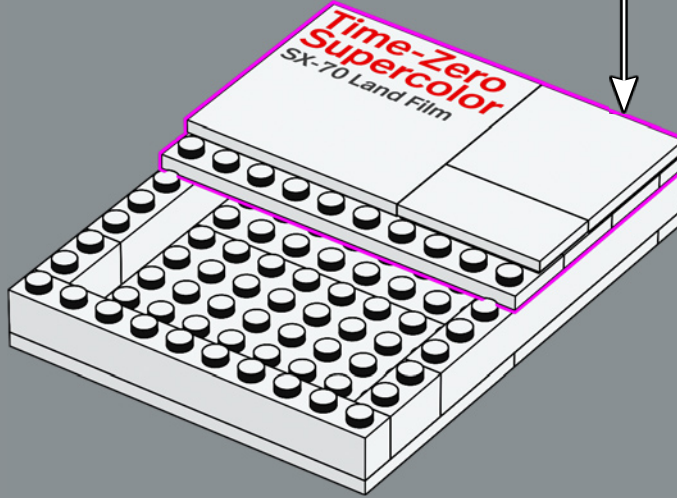
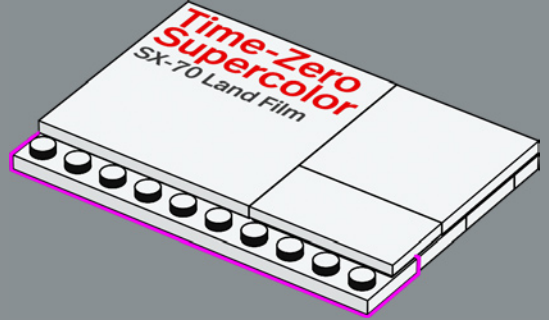

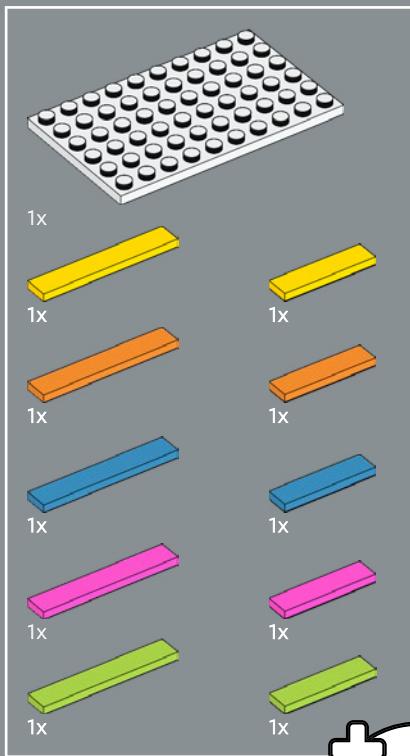

6

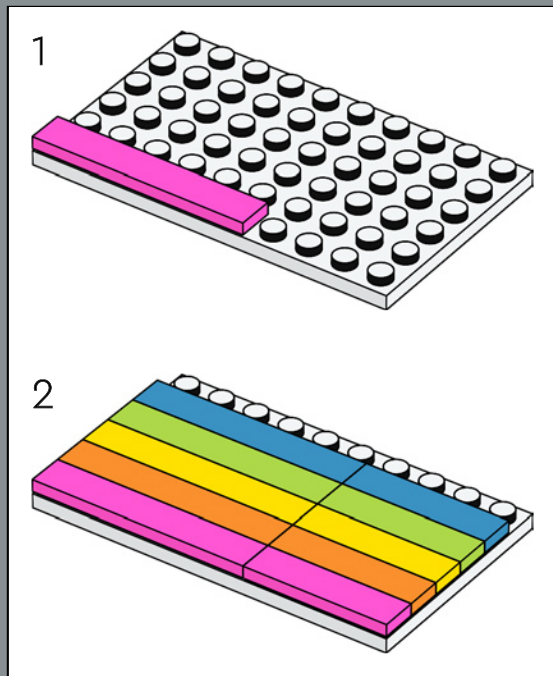
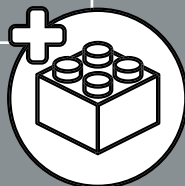

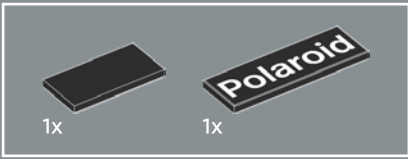

7



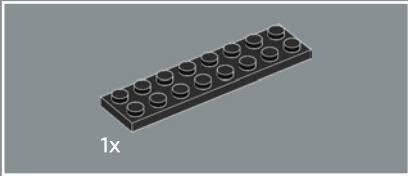
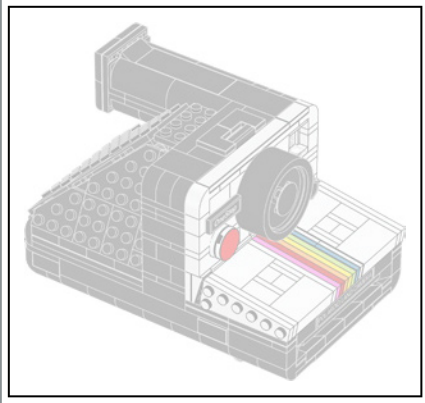

8

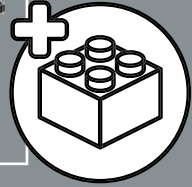
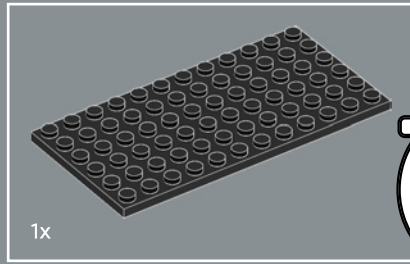
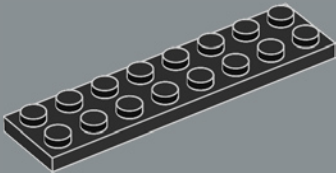

9

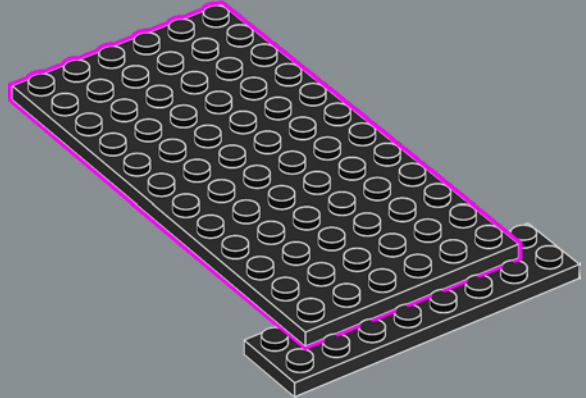

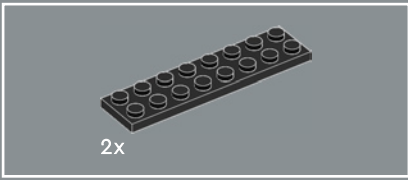

10

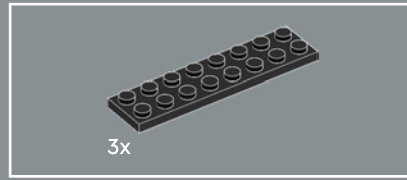
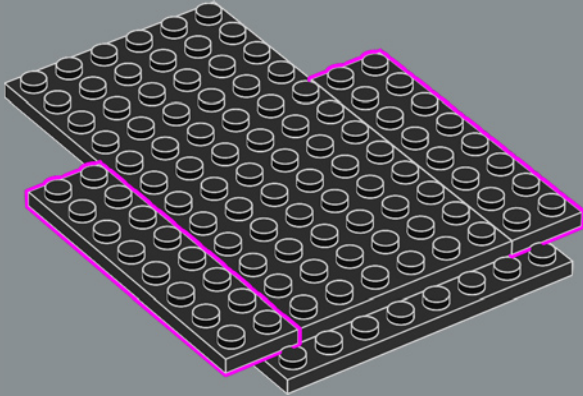

11

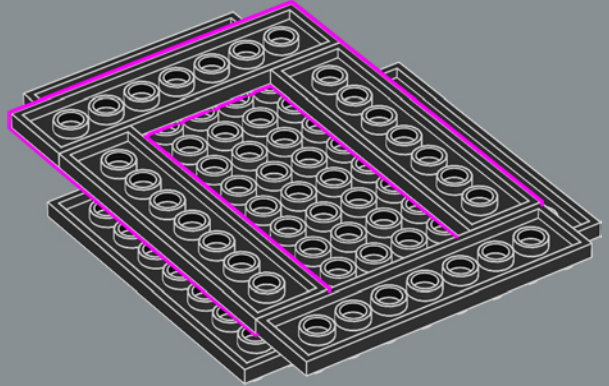

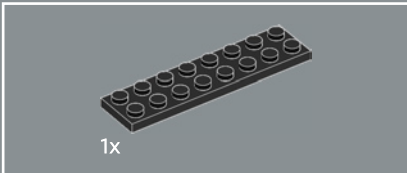
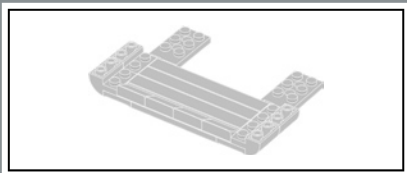

12

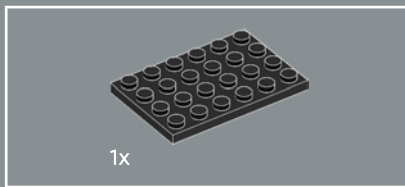
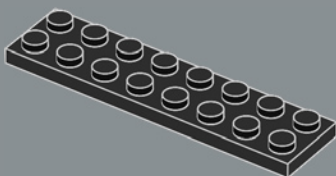

13

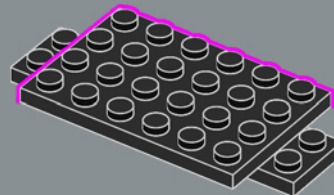



14

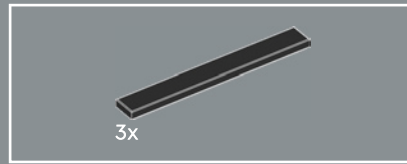
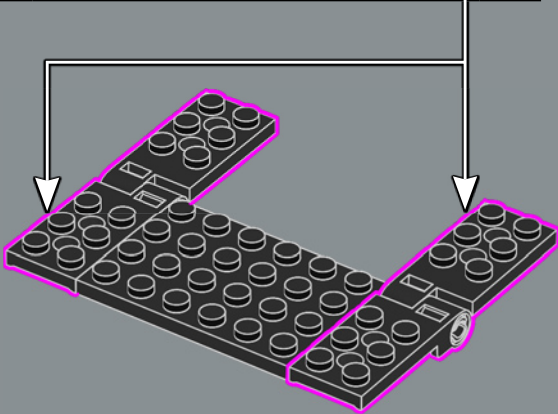
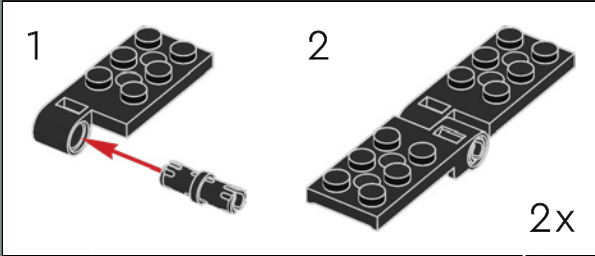

15

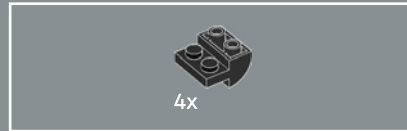
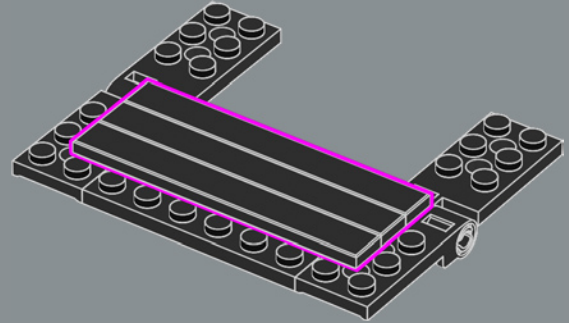

16

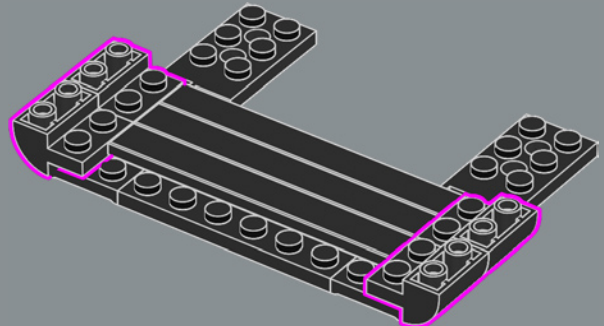



17

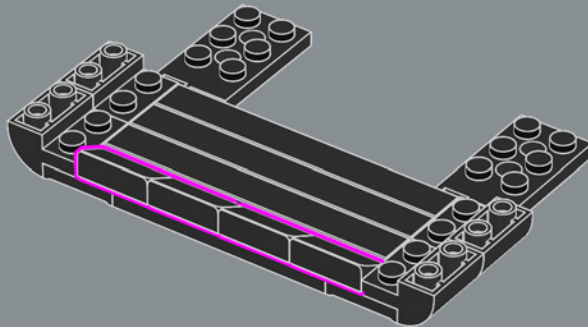

18

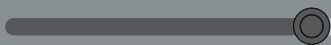
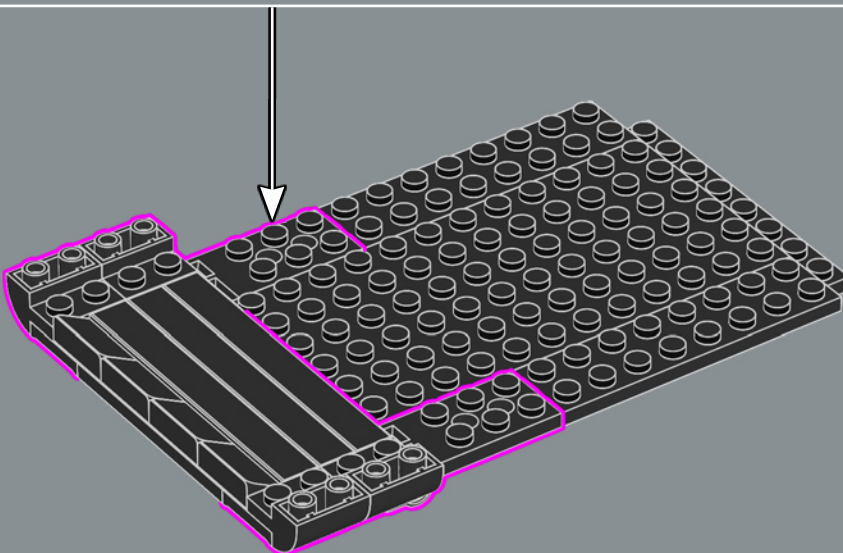

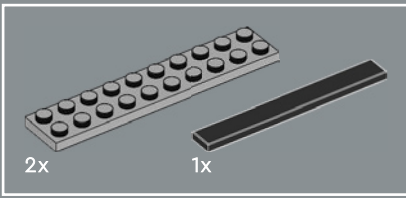

19

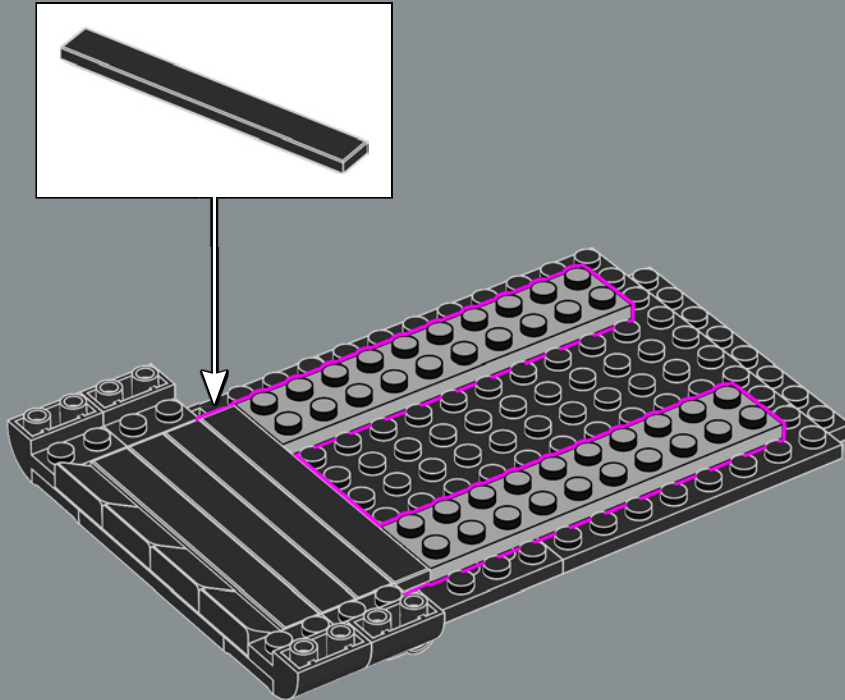

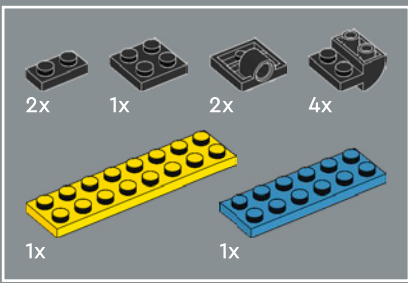

20

1

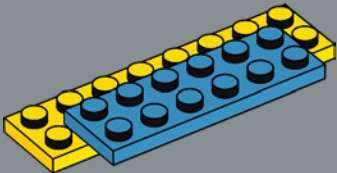

2

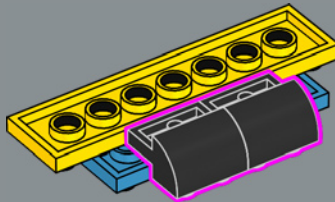

3

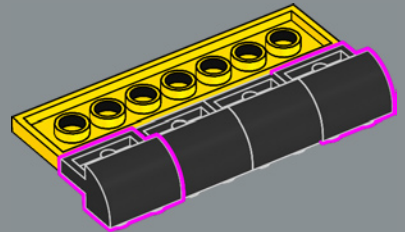

4

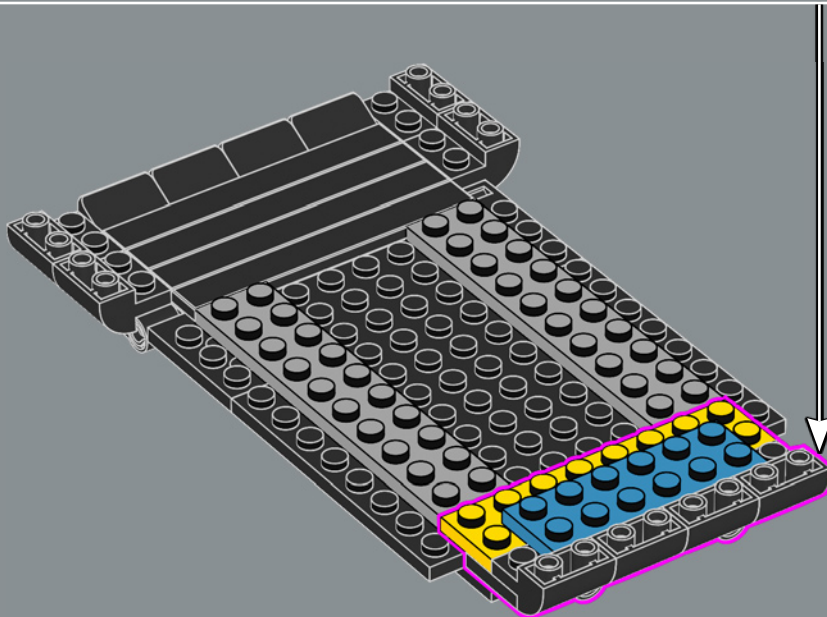
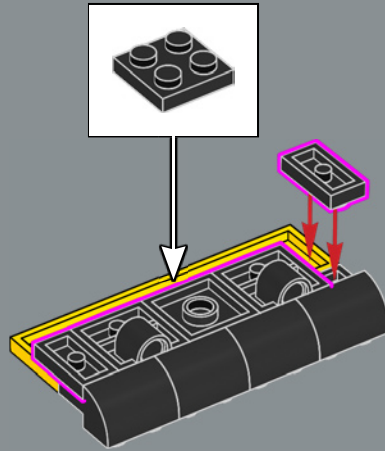



12x

21

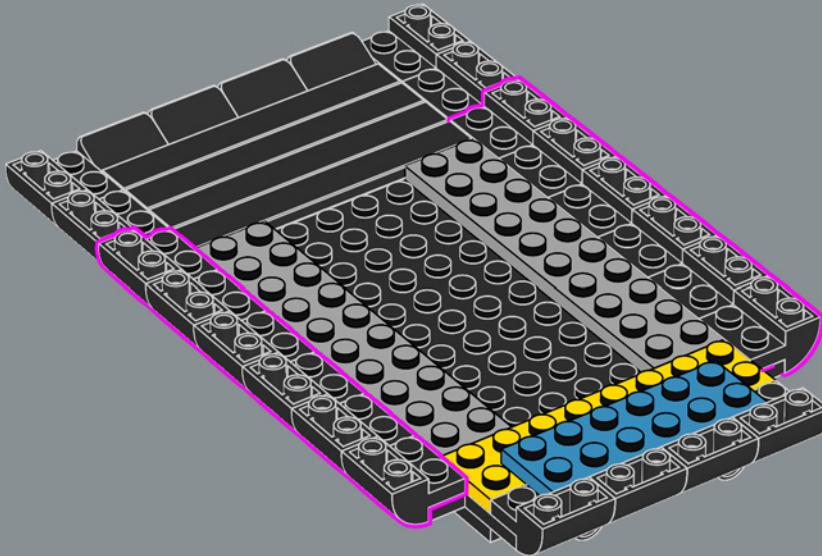

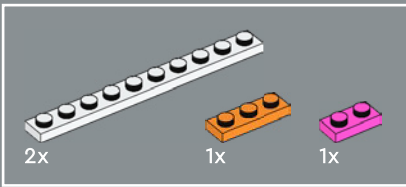

22

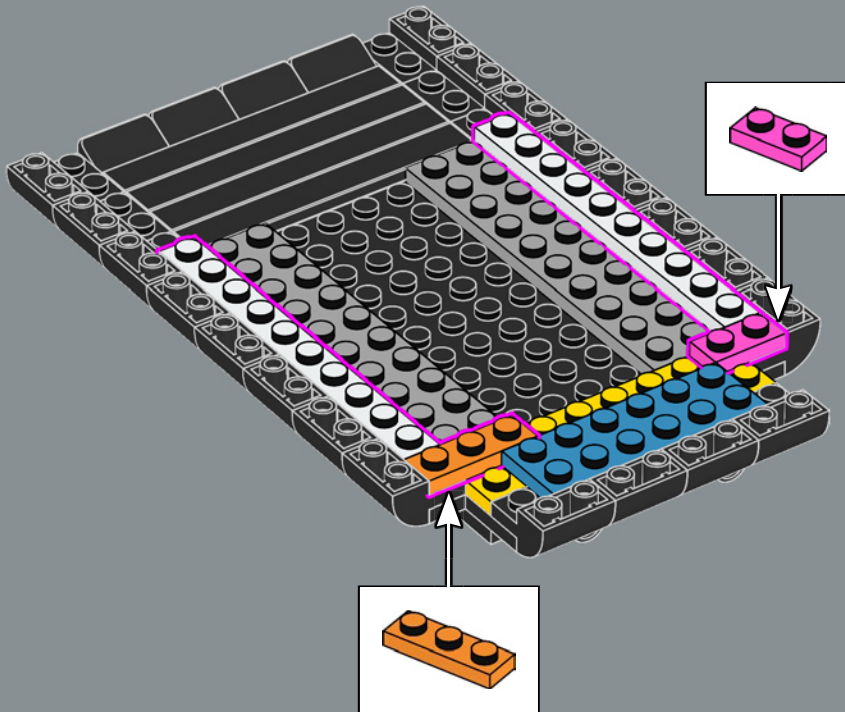

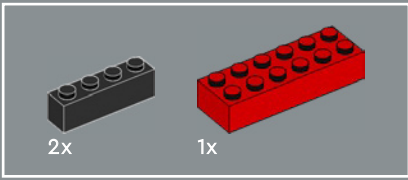

23

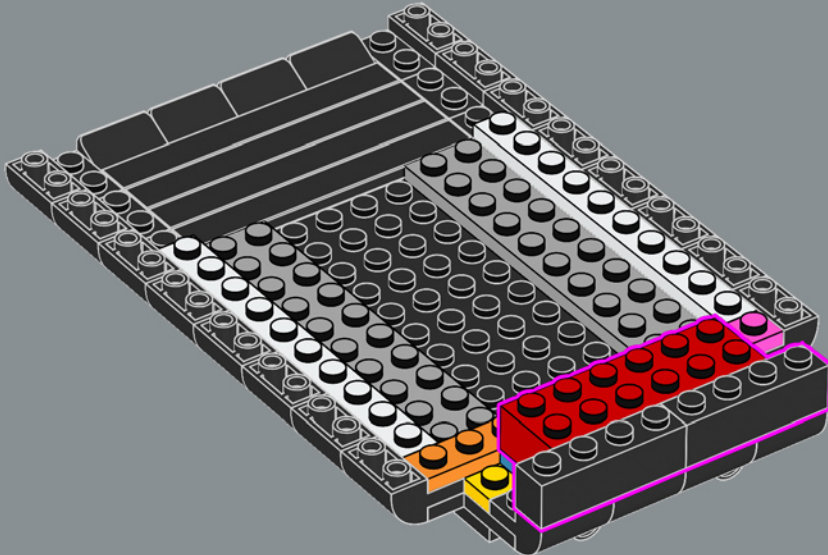

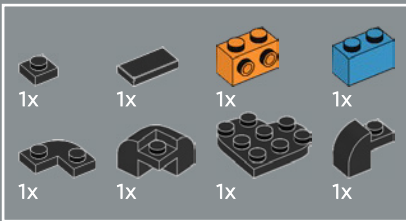

24

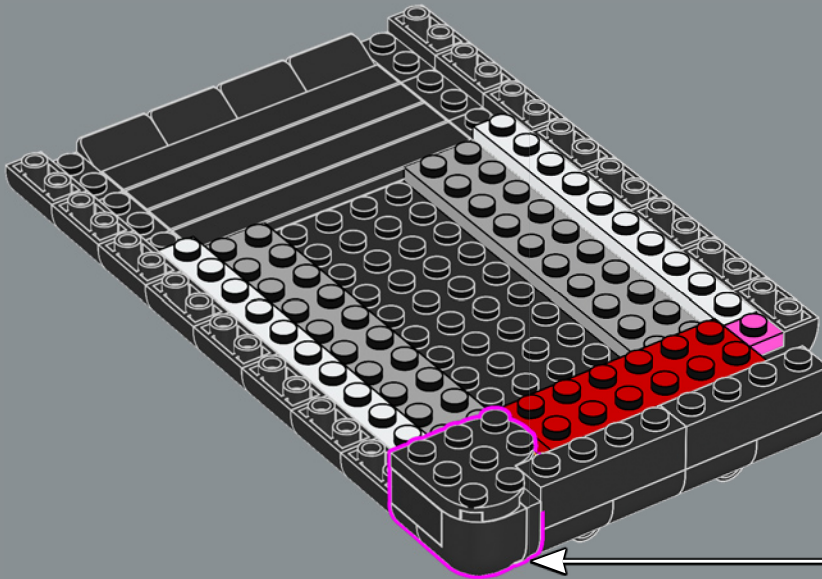
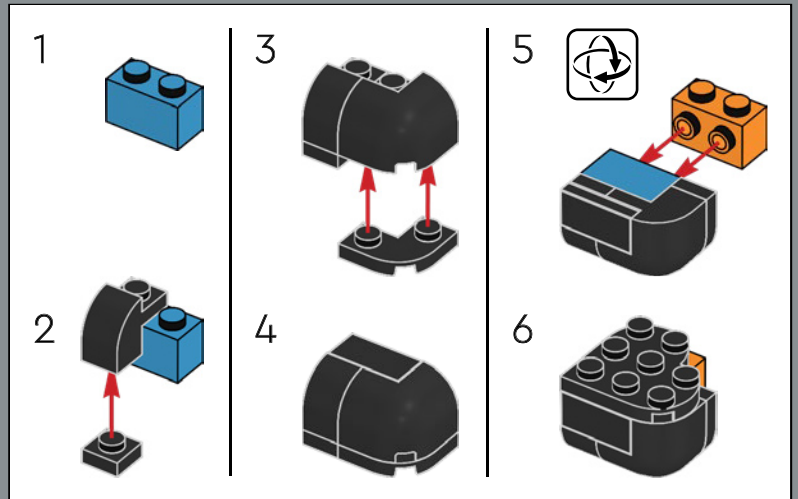

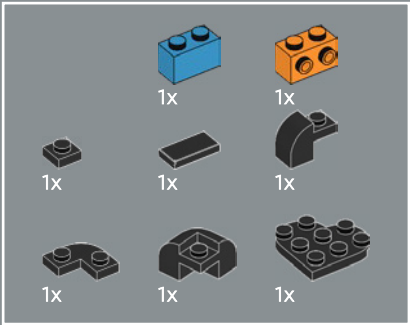

25

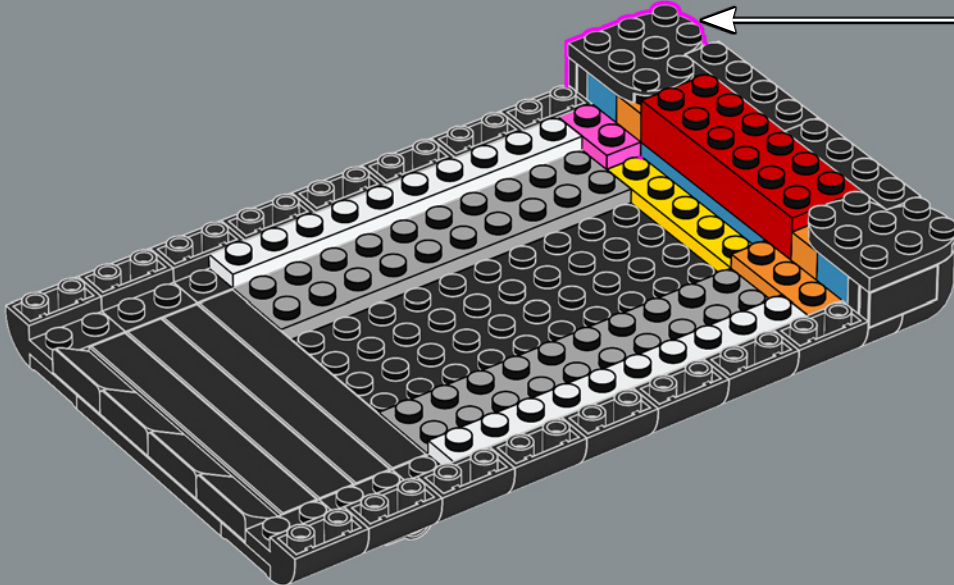
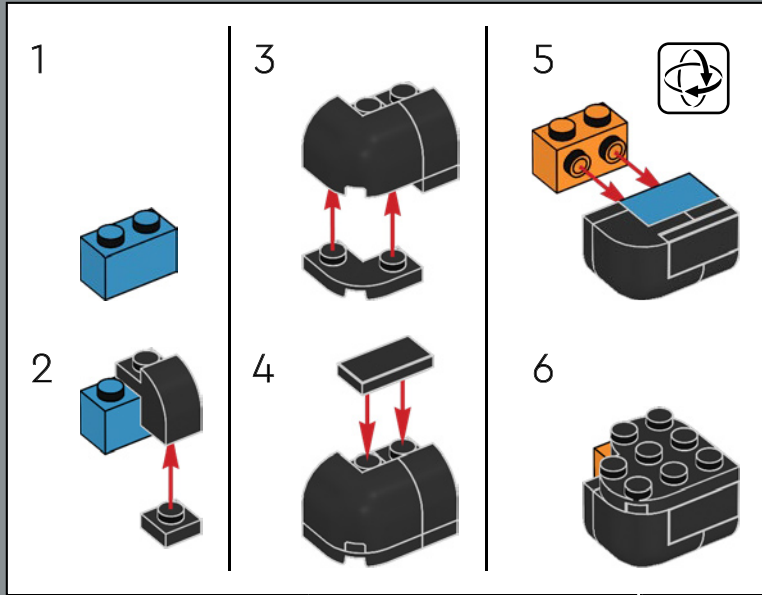

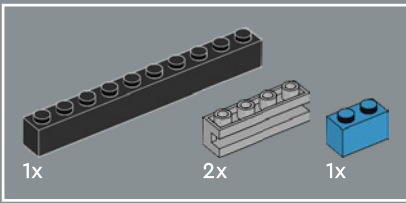

26

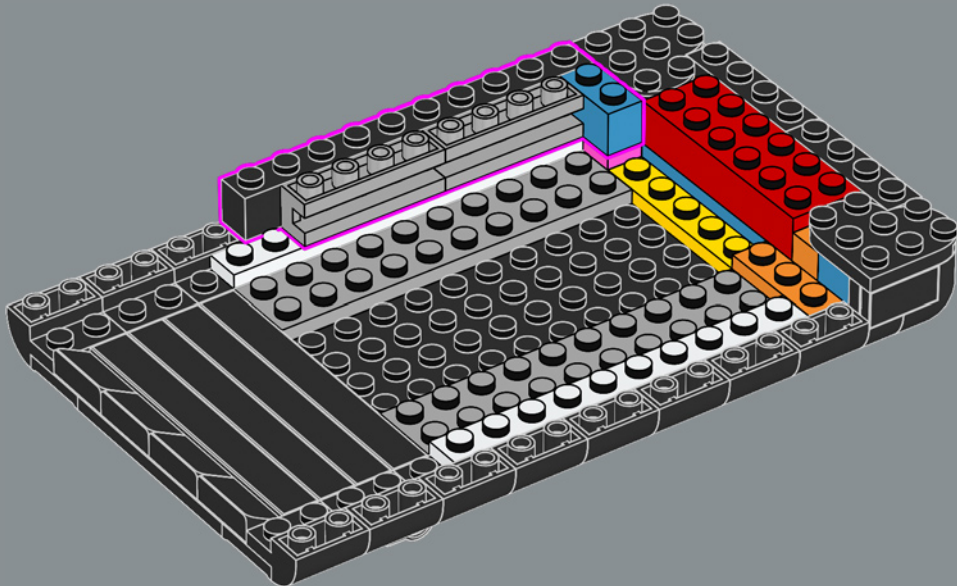

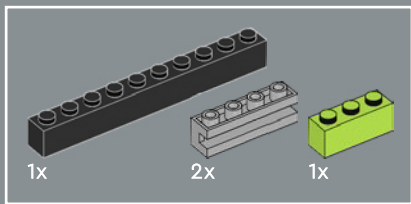

27

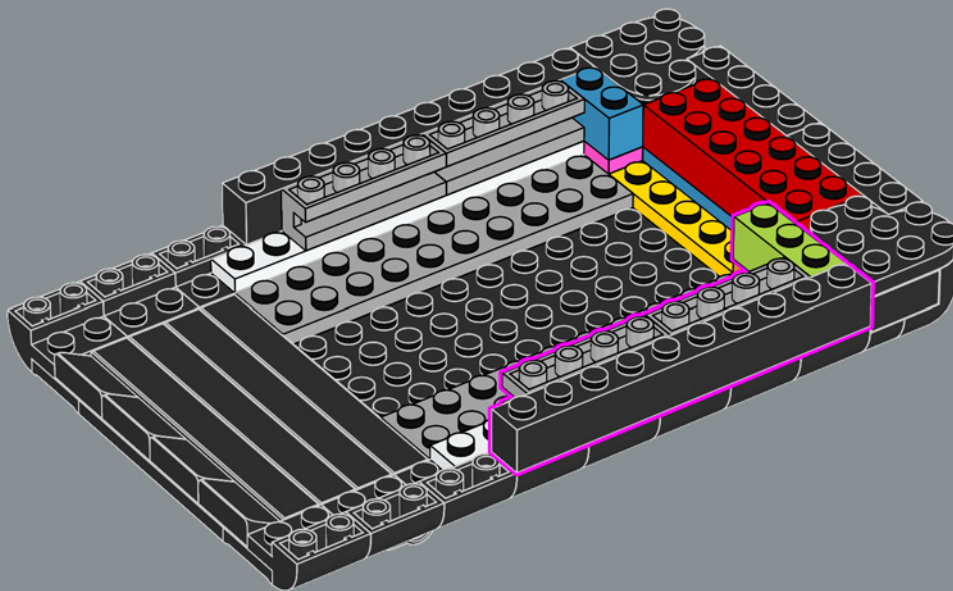

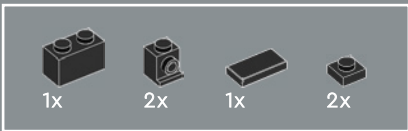

28

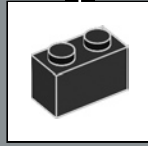
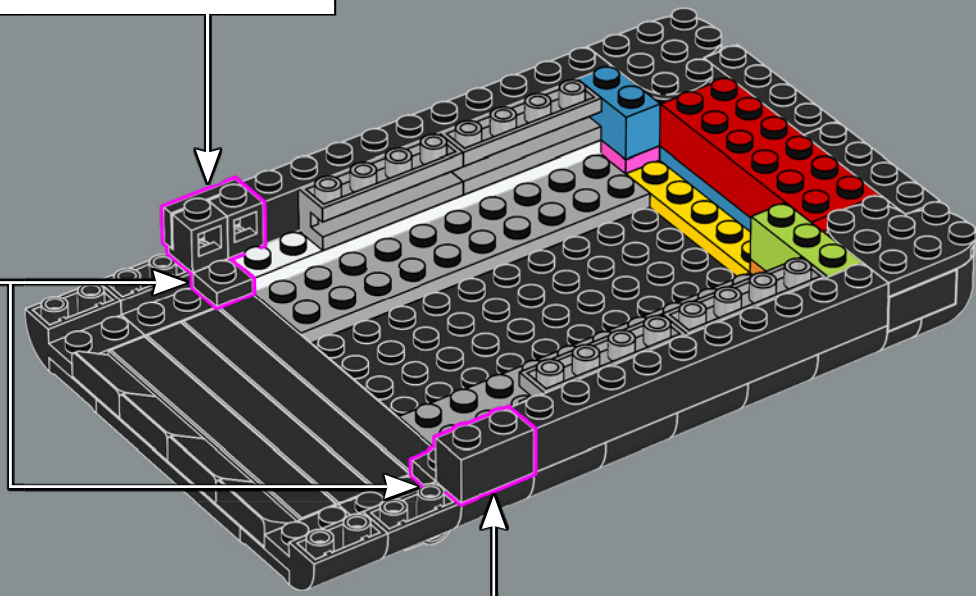
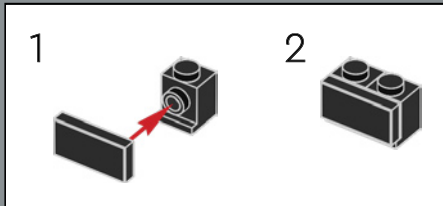

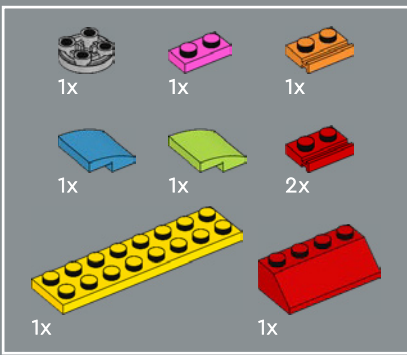

29

1

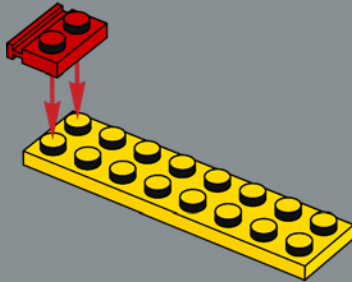

2

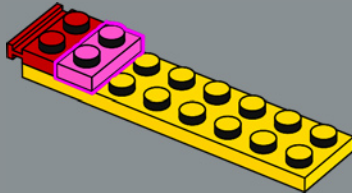

3

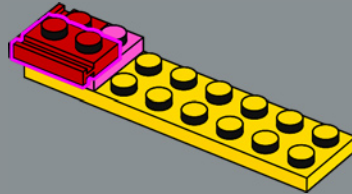

4

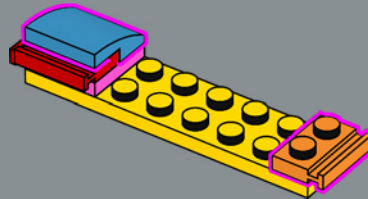

5

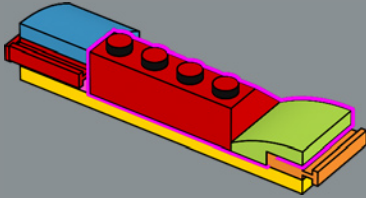

6

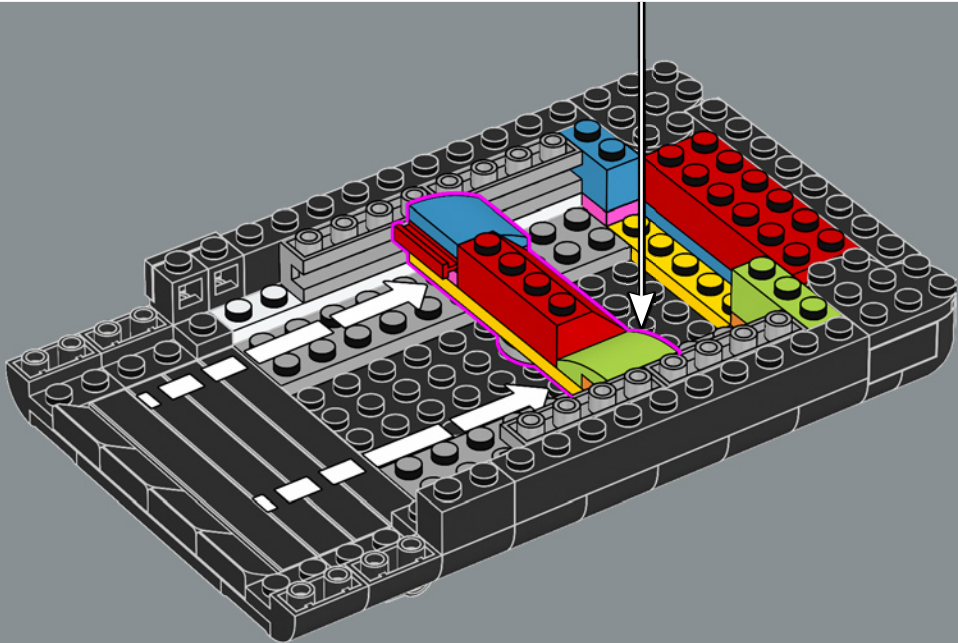
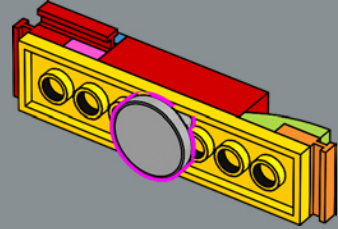



30

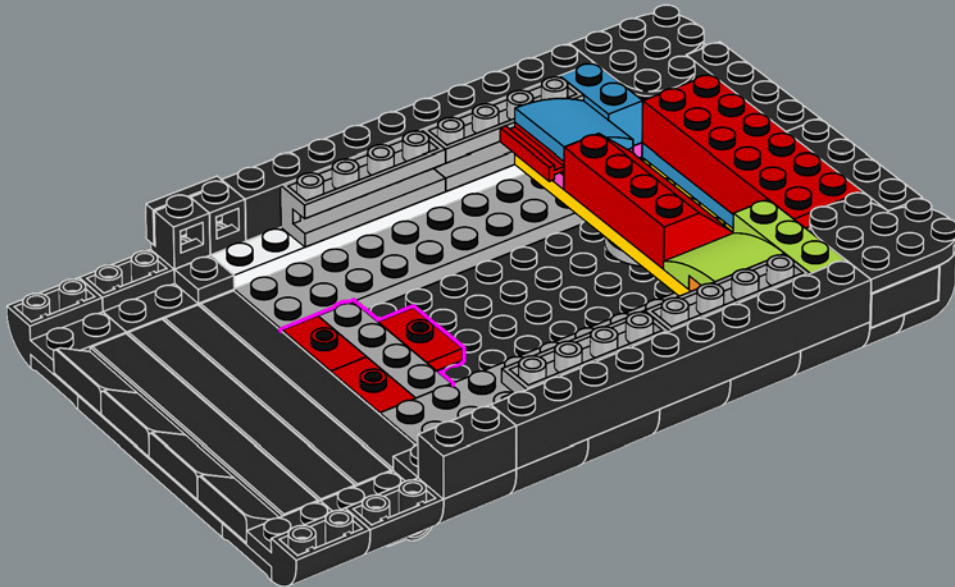

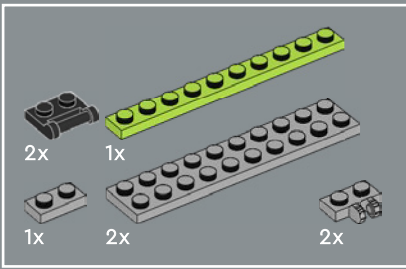

31

1

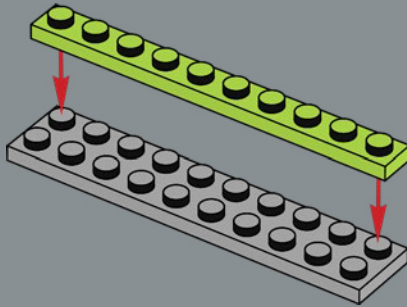

2

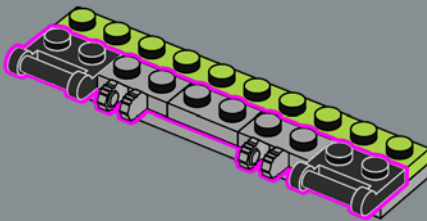

3

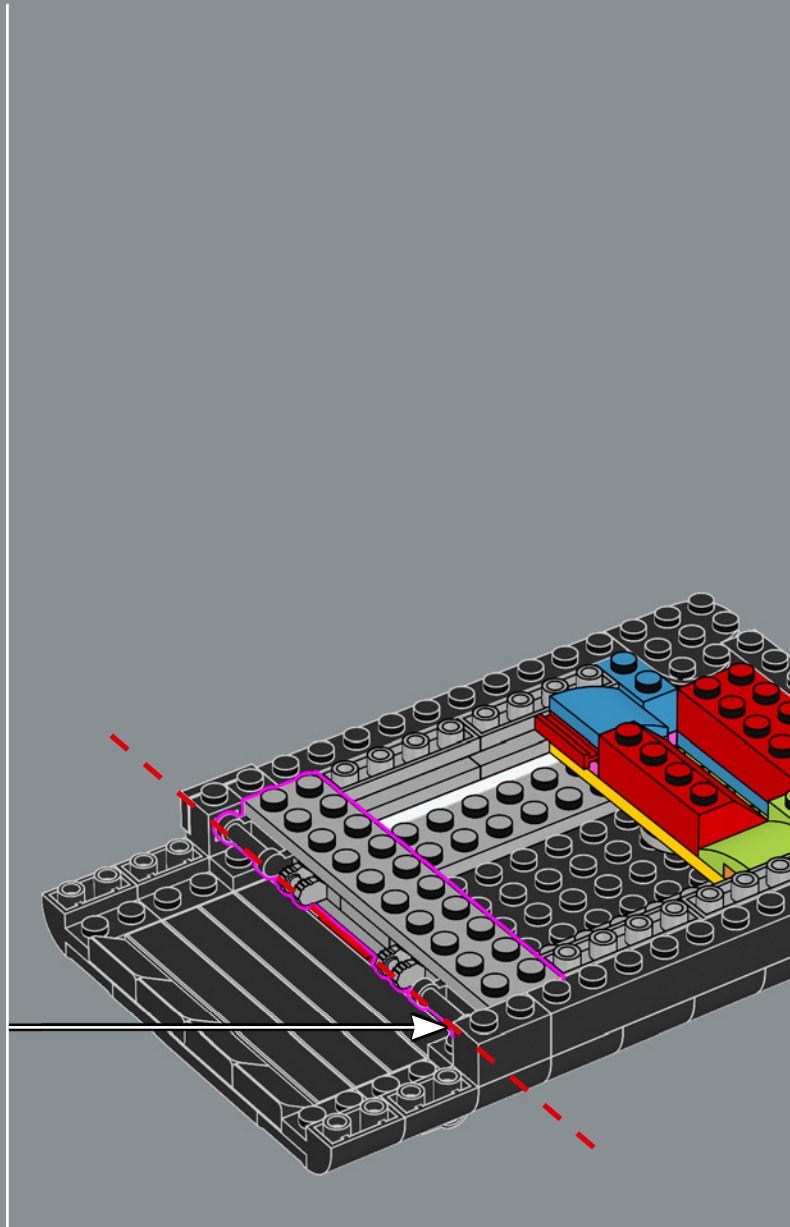
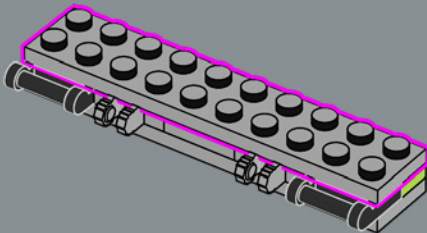

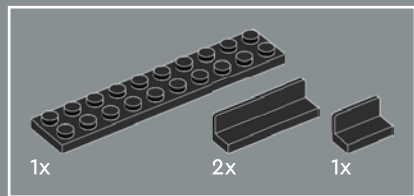

32

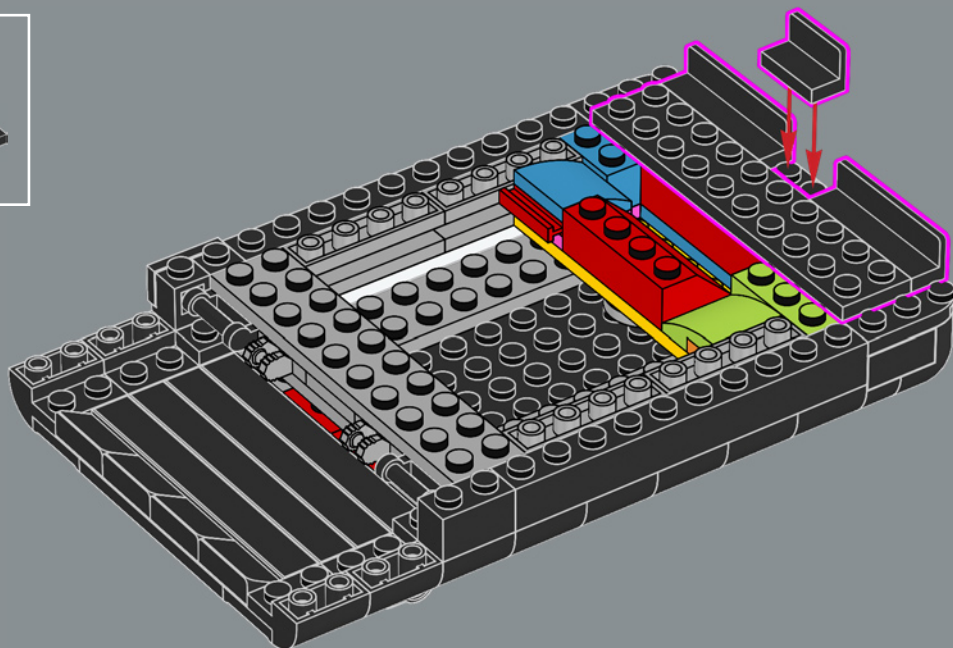

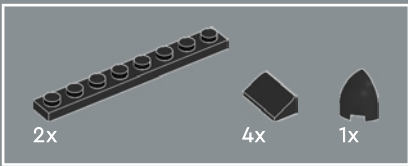

33

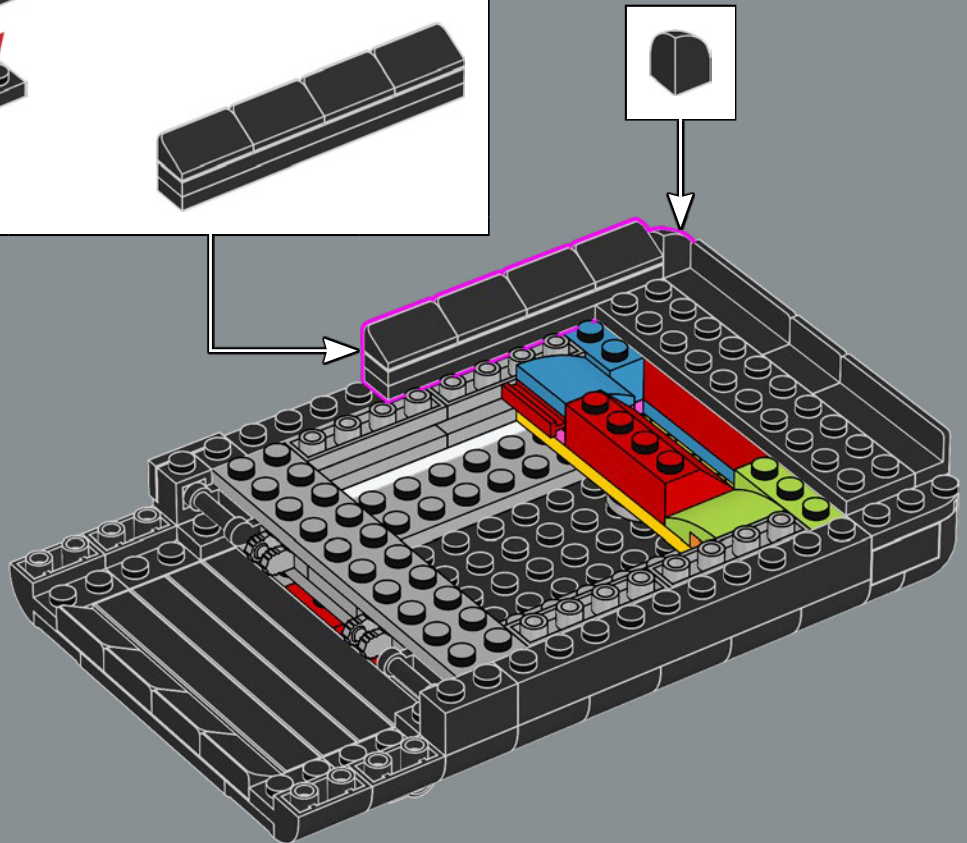
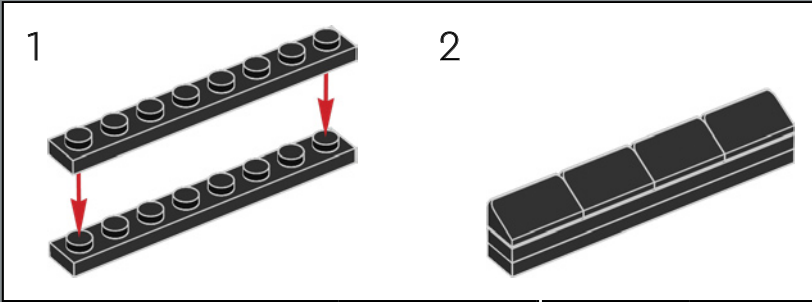

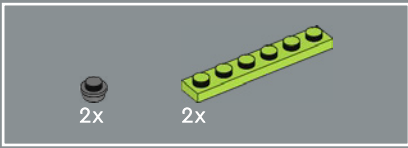

34

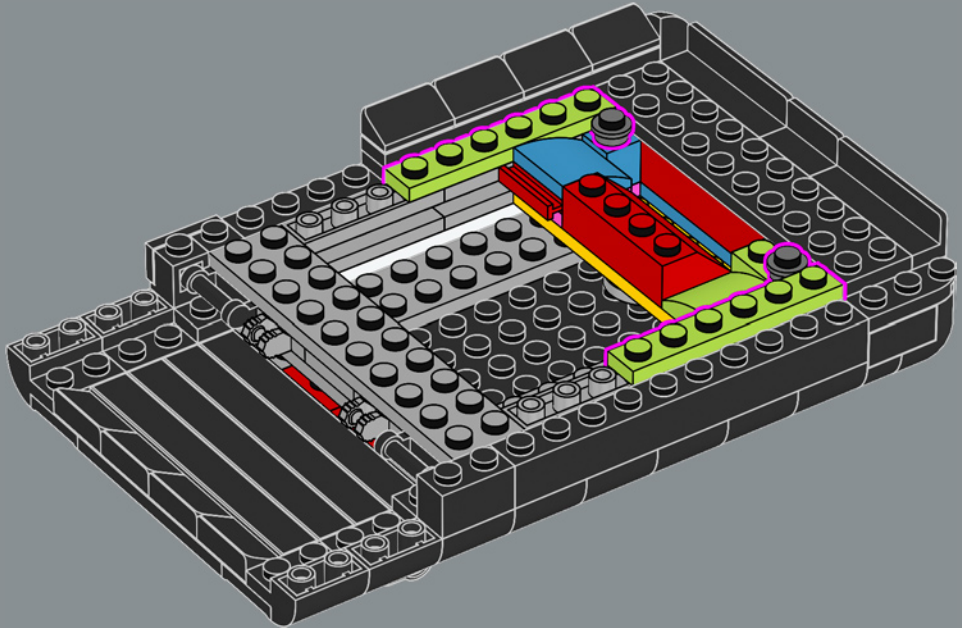

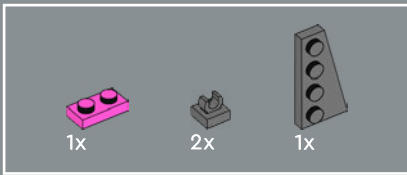

35

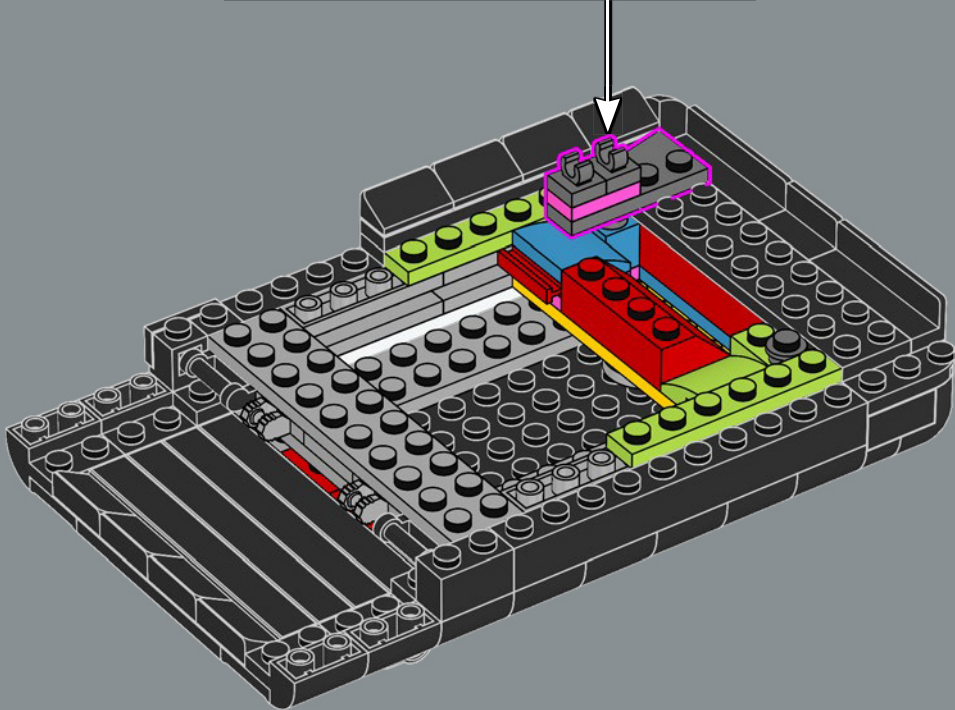
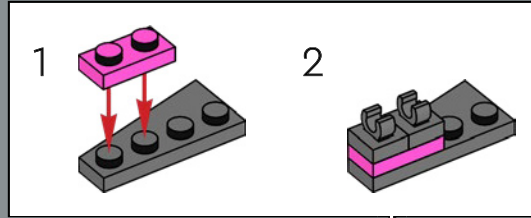



6x

36

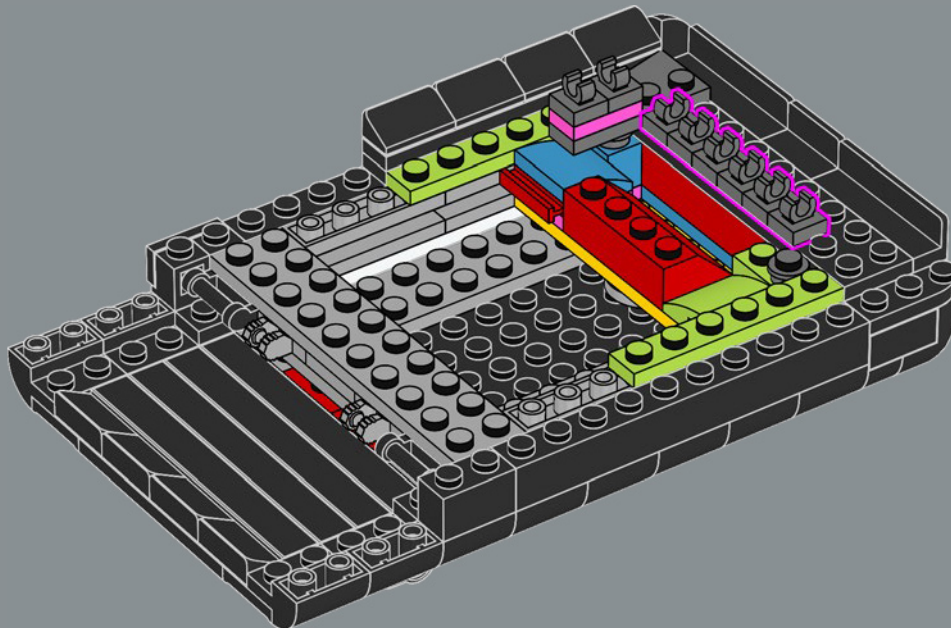

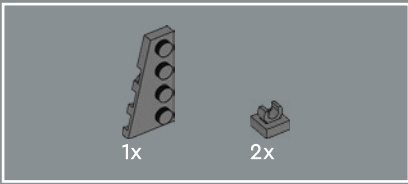

37

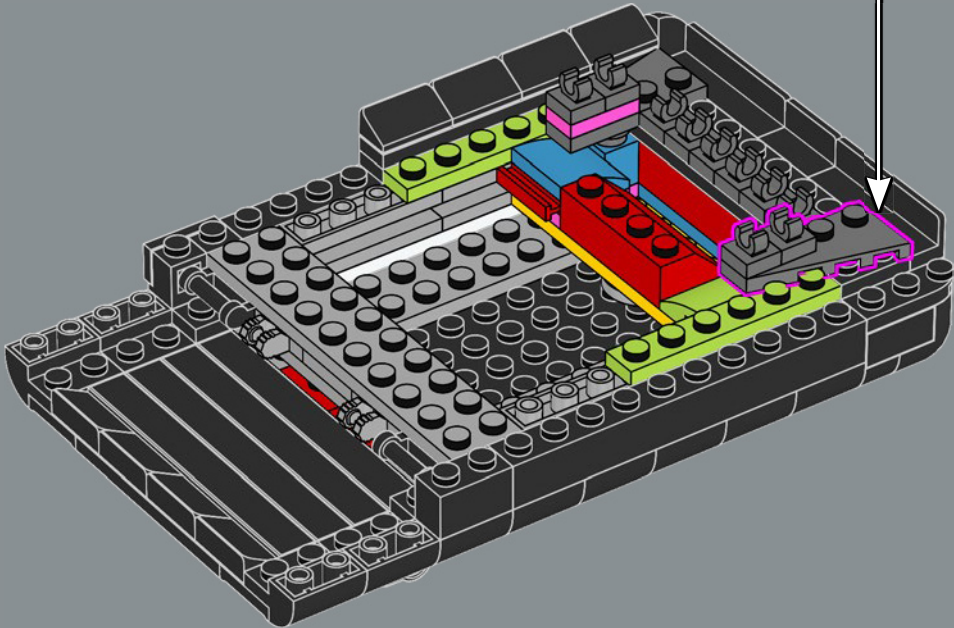
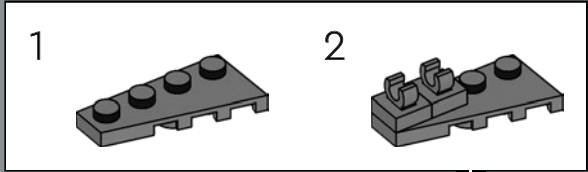

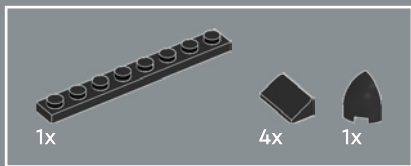

38

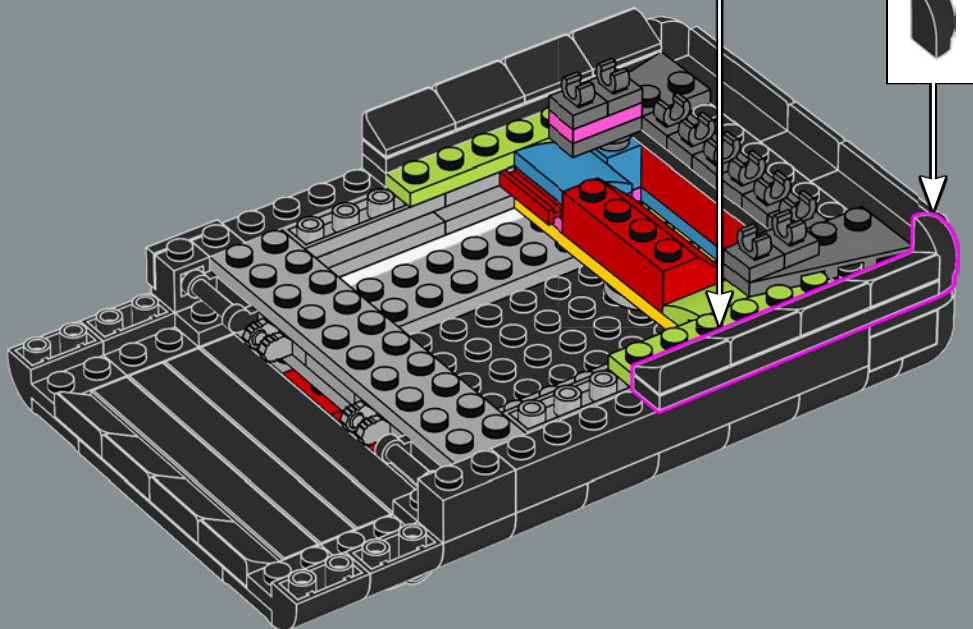
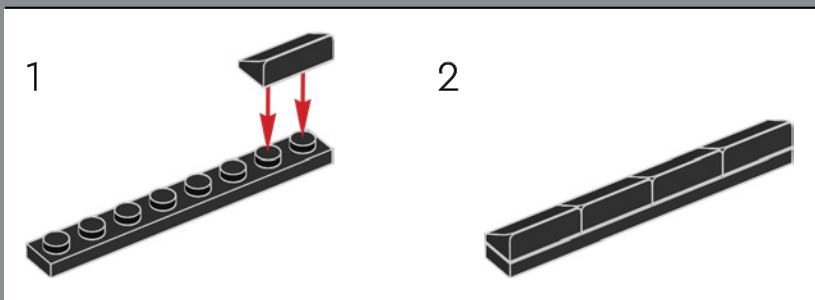

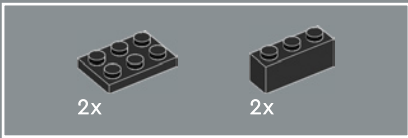

39

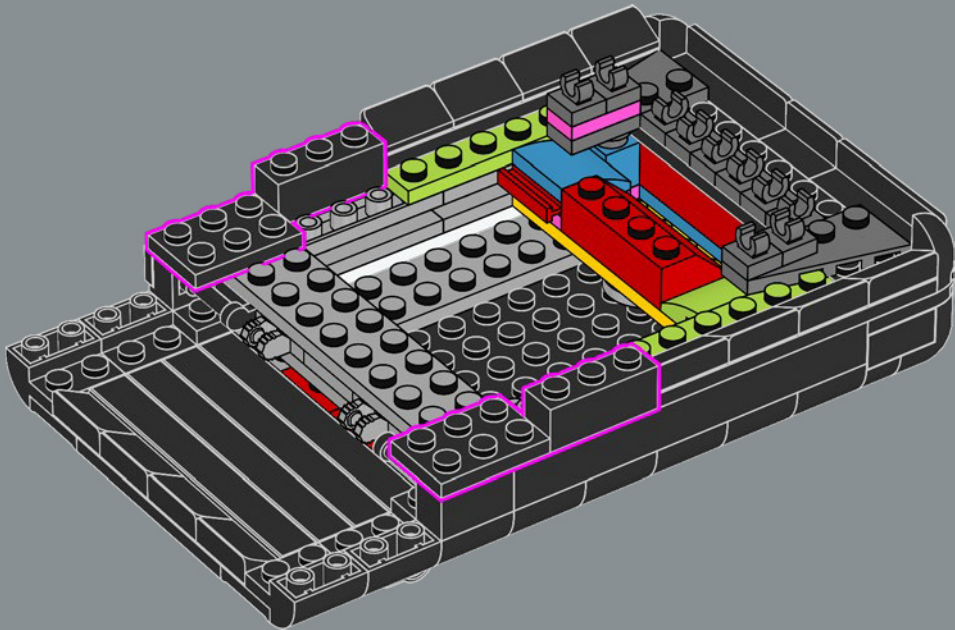



40

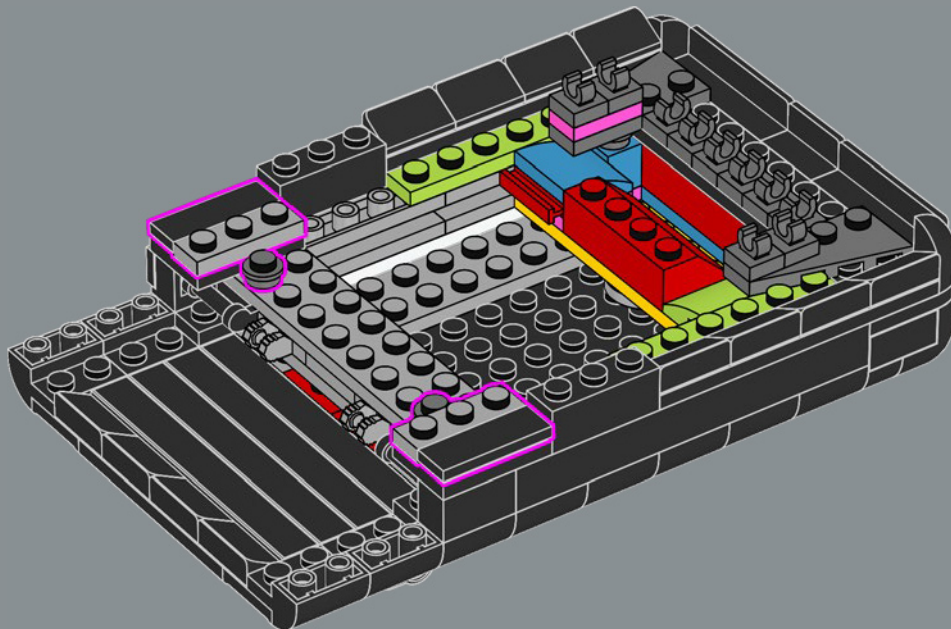

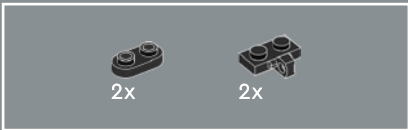

41

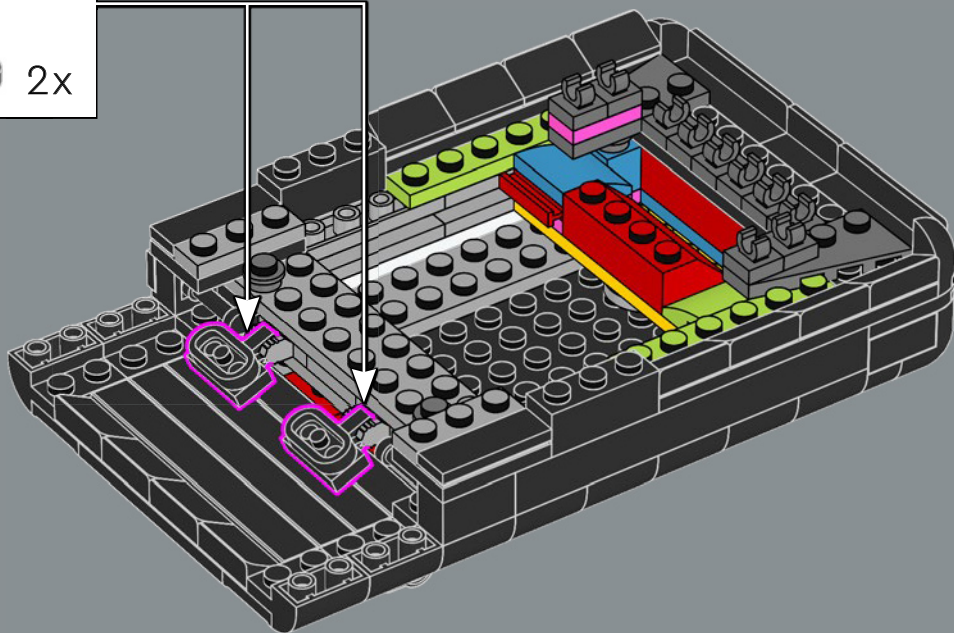
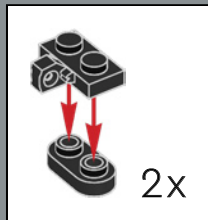

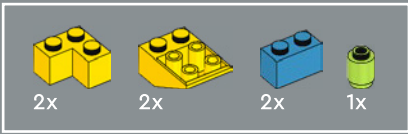

42

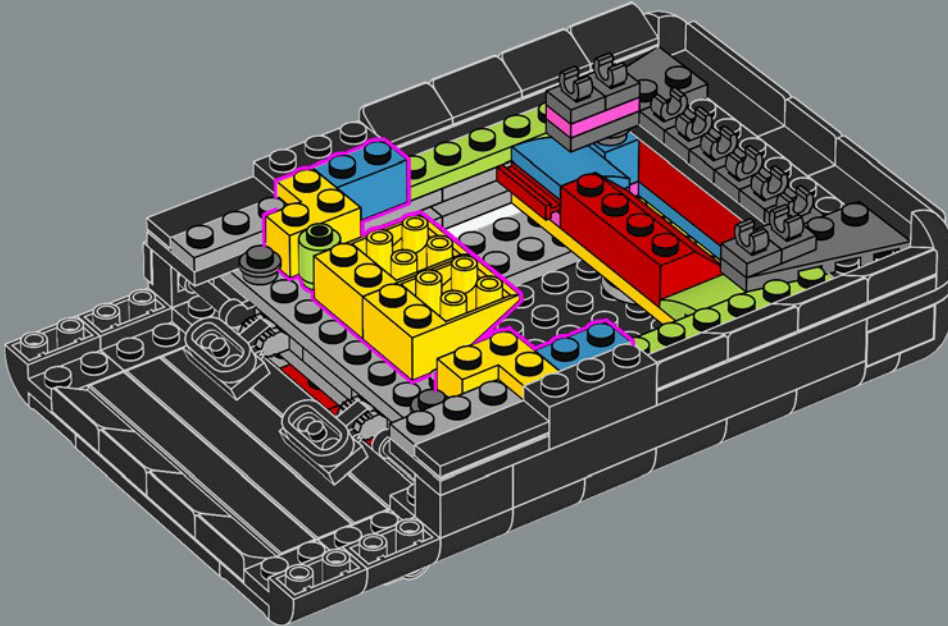

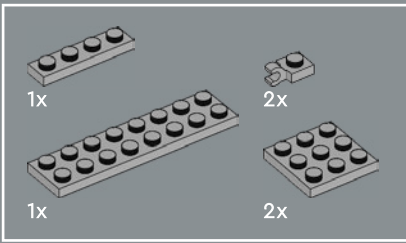

43

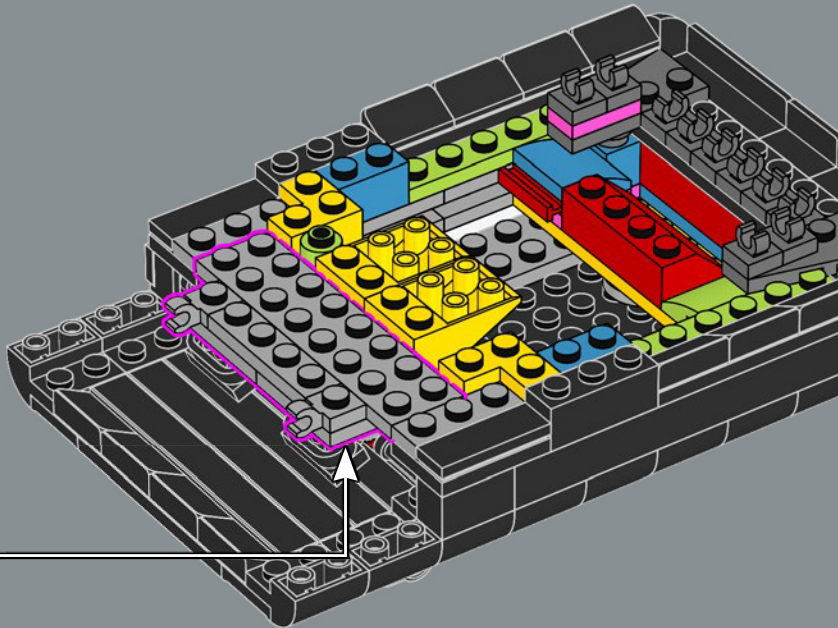
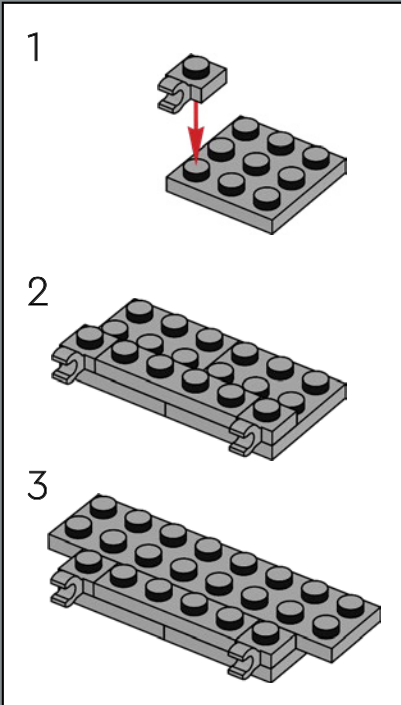

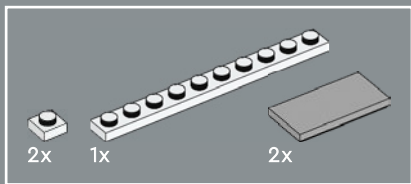

44

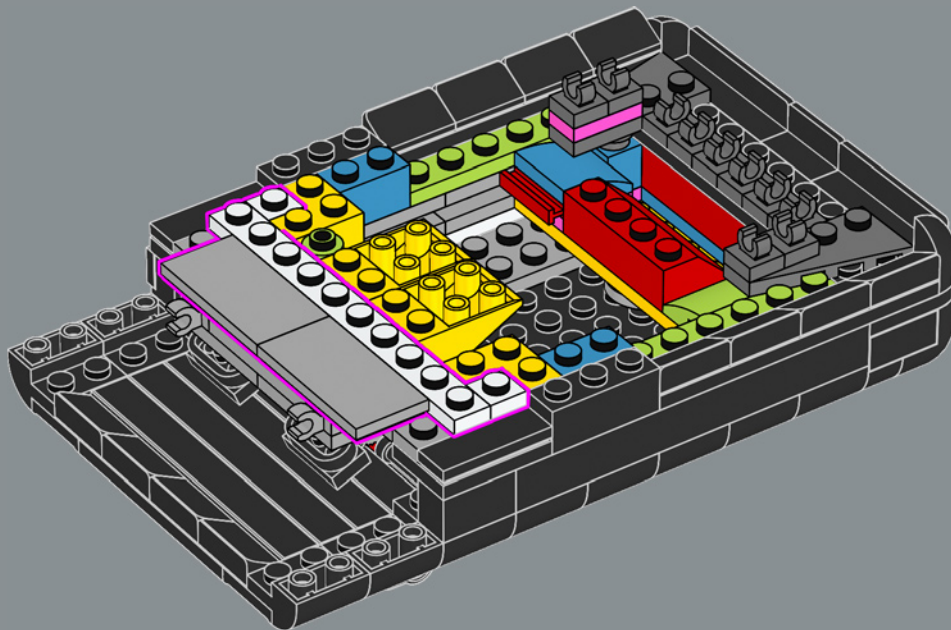

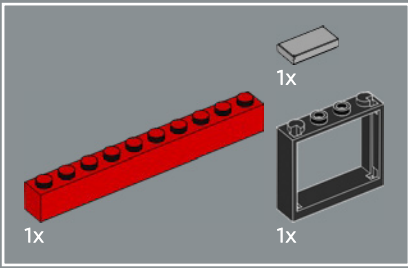

45

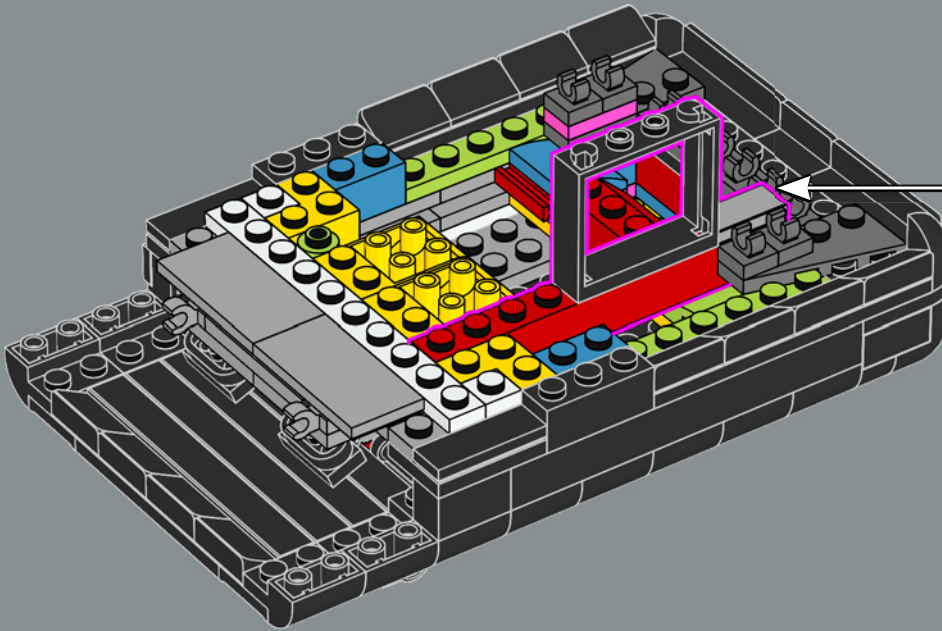
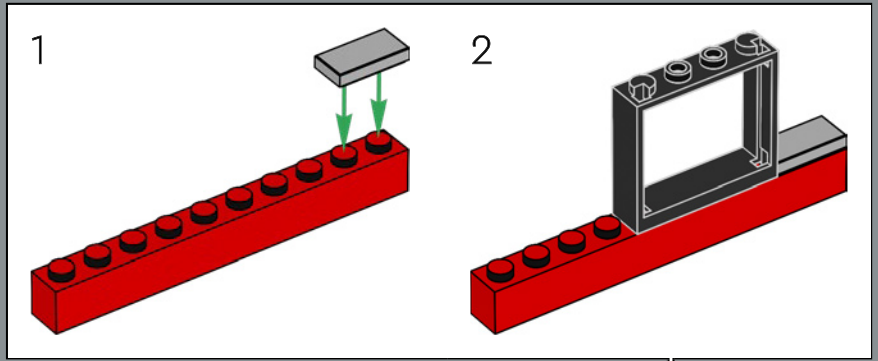

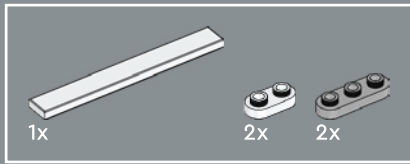

46

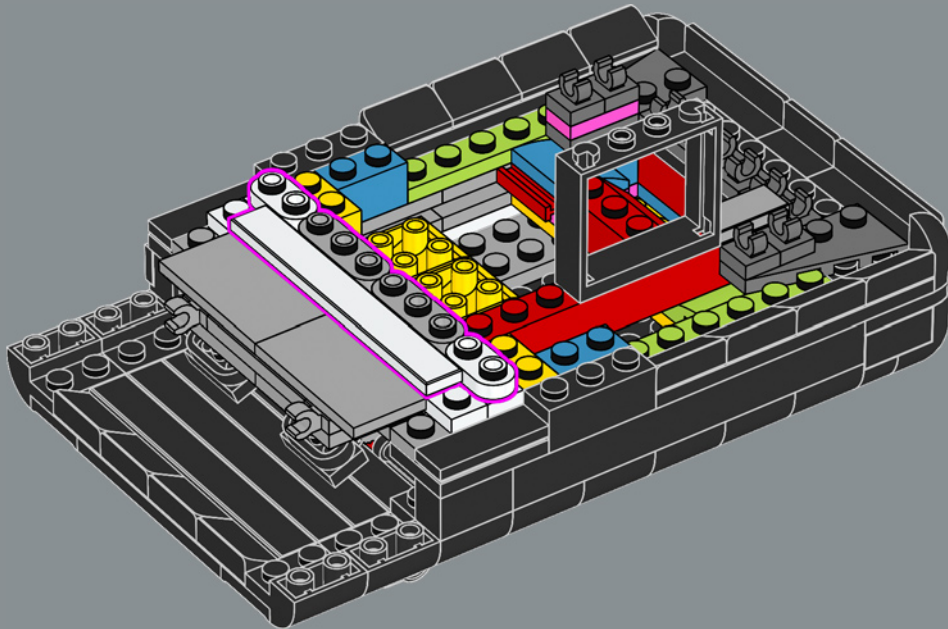

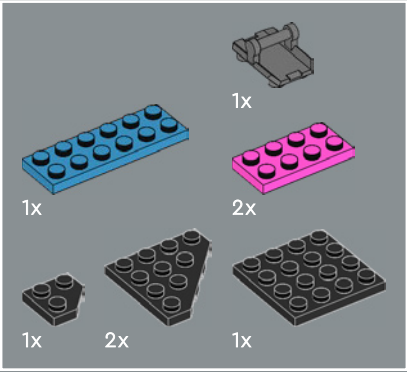
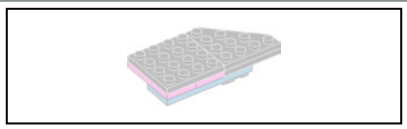

47

1

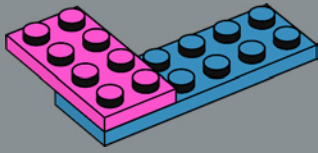

2

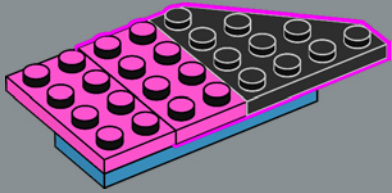

3

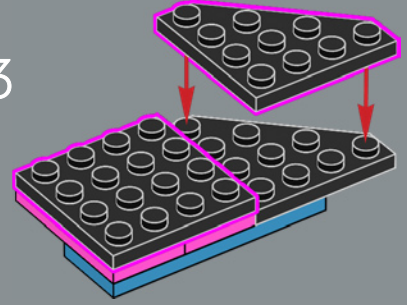

4

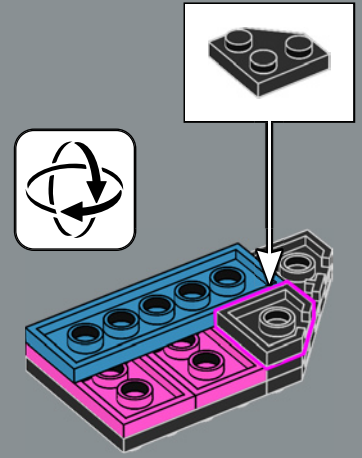

5

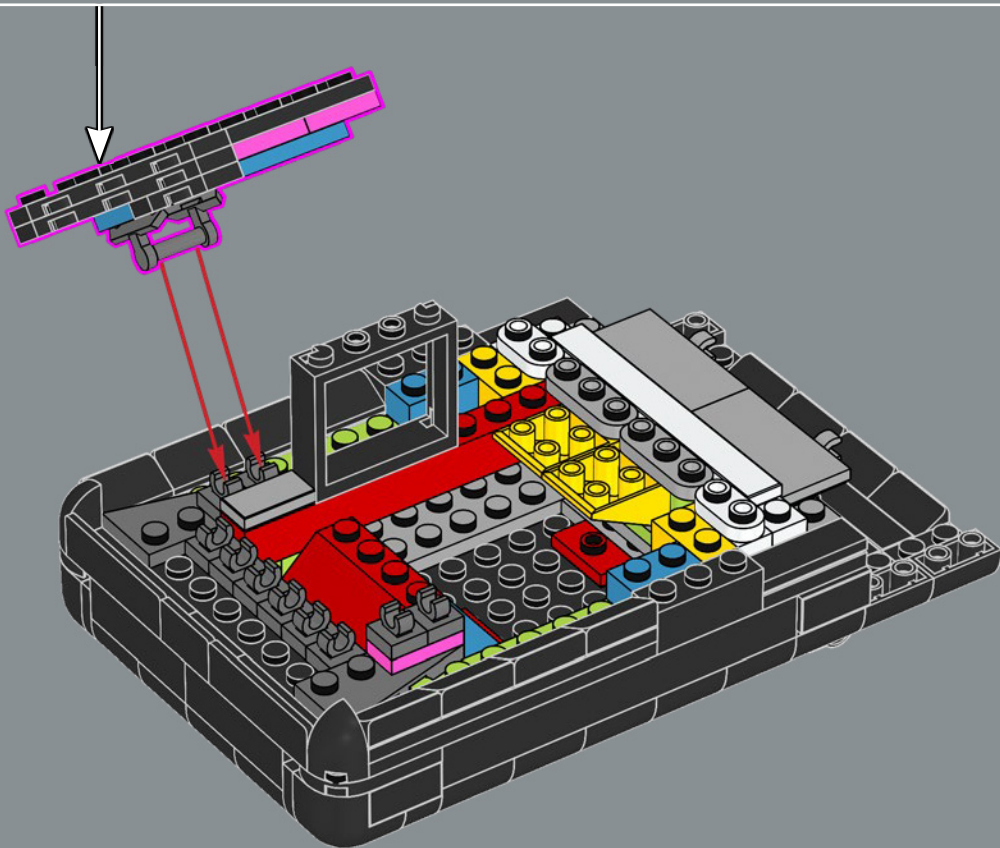
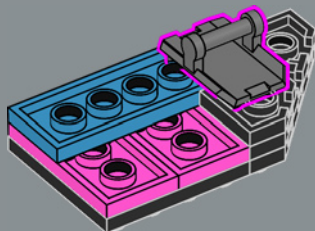

2x

48

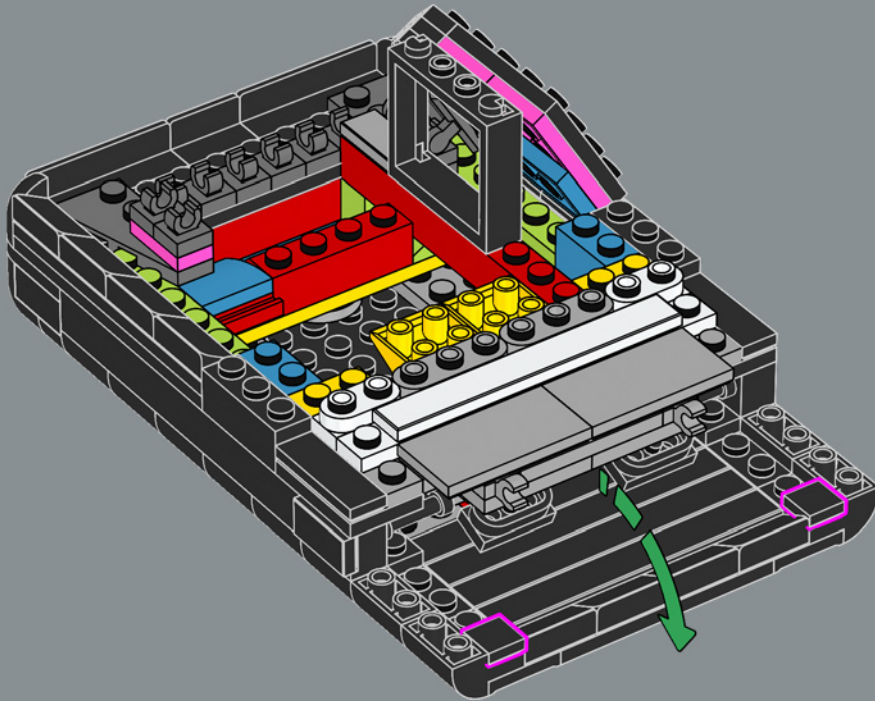

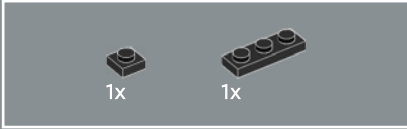
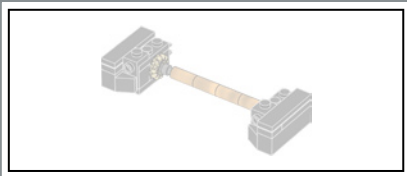

49

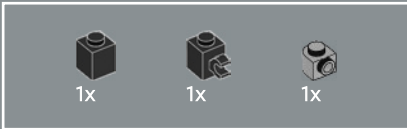
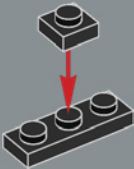

50

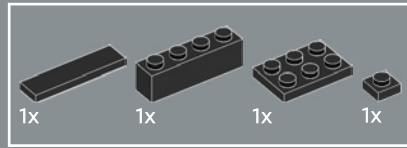
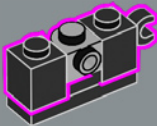

51

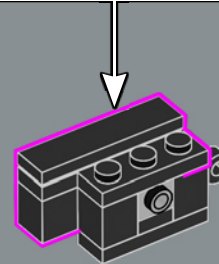
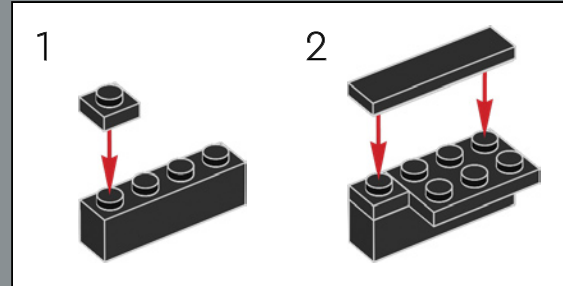



52

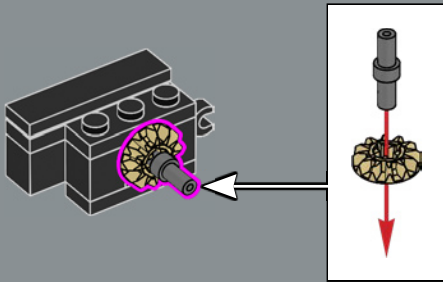

53

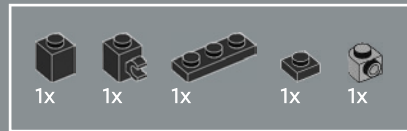
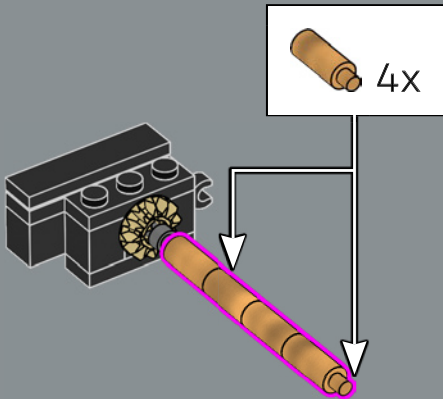

54

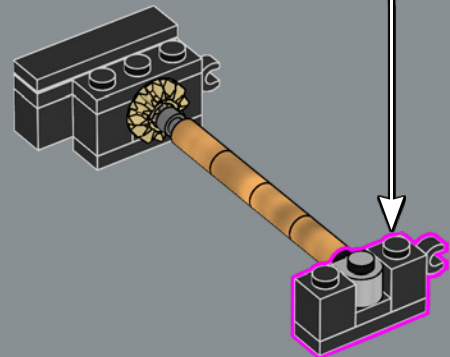
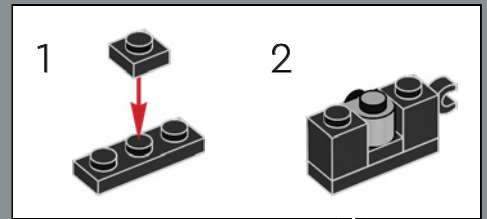

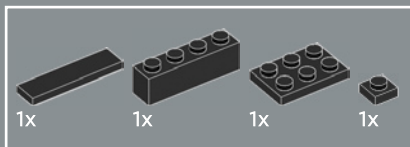

55

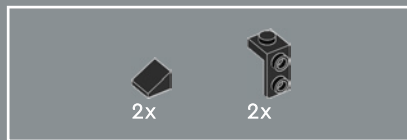
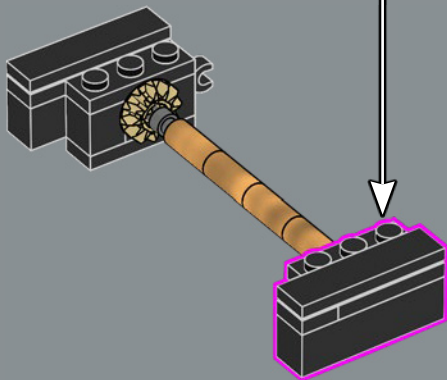
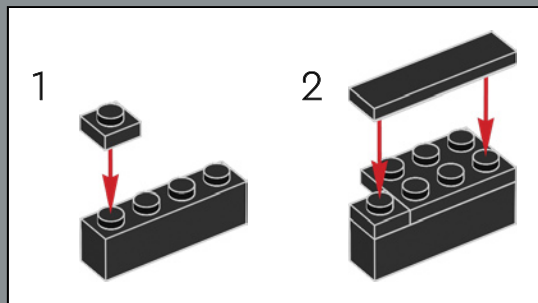

56

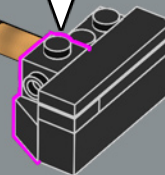
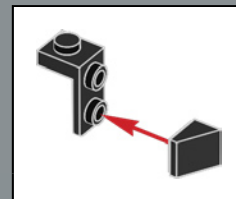
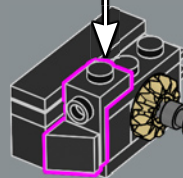
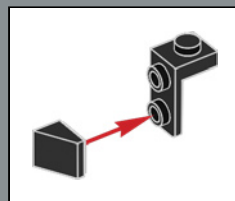

57

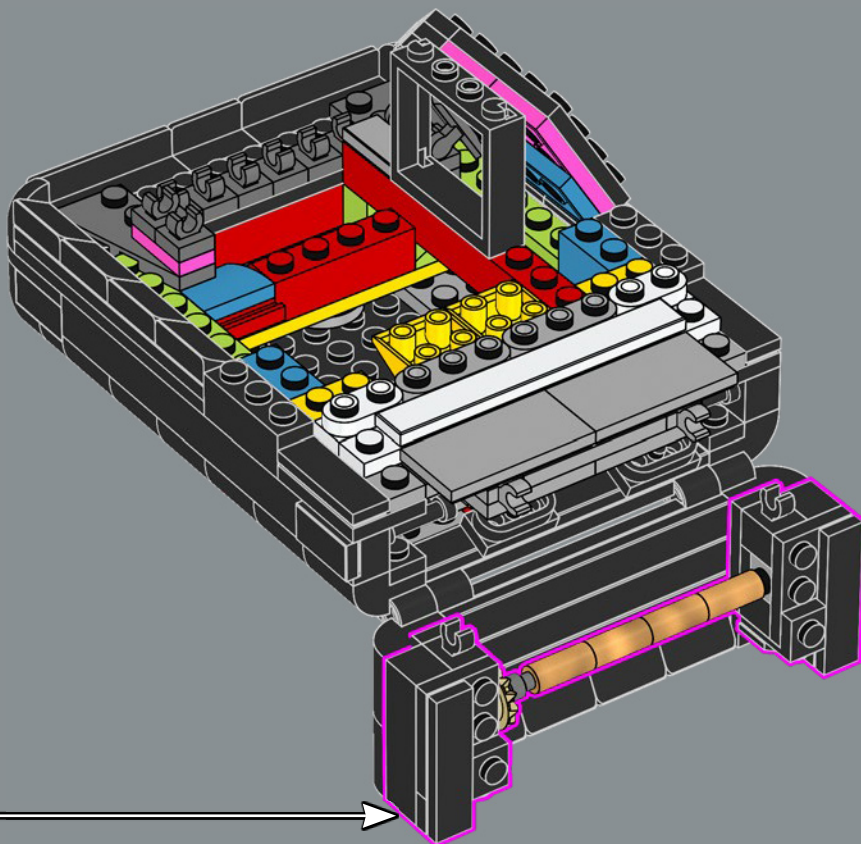

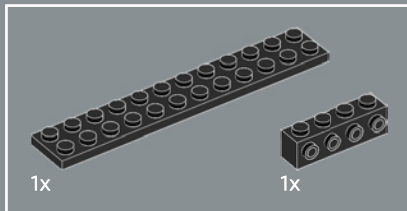
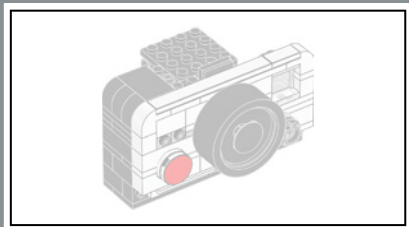
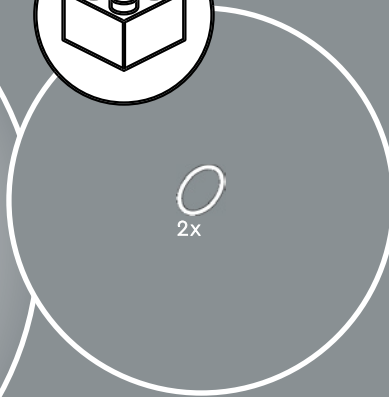
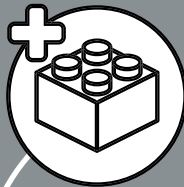

58

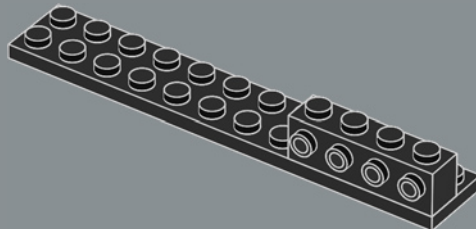

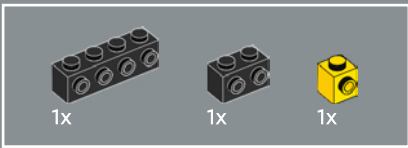

59

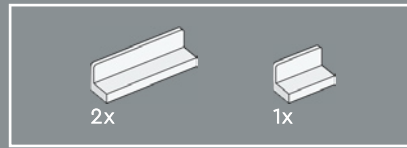
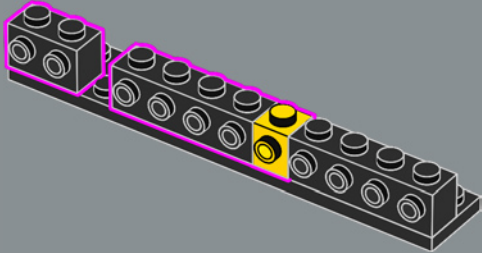

60

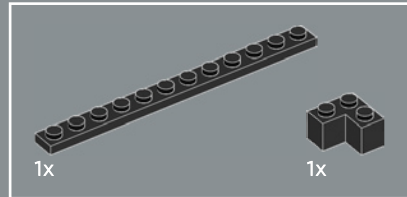
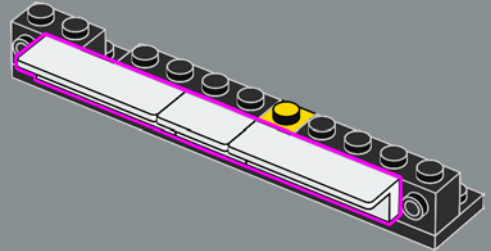

61

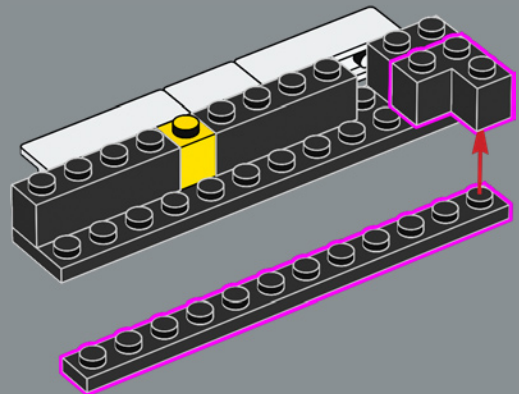

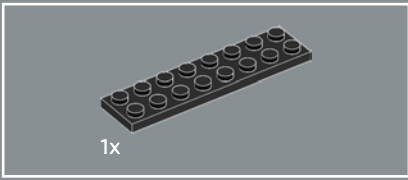

62

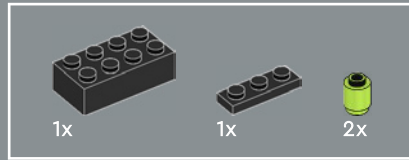
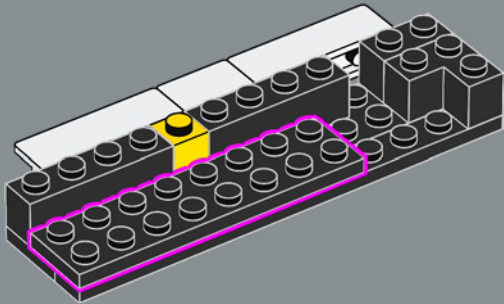

63

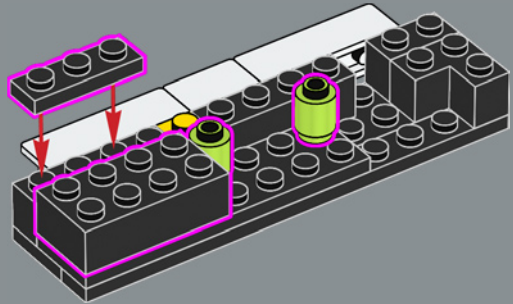

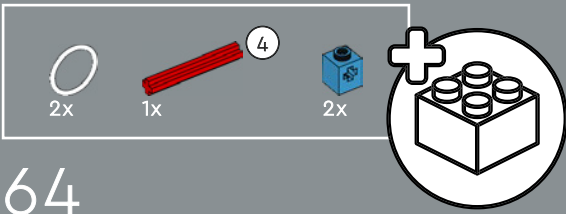

64

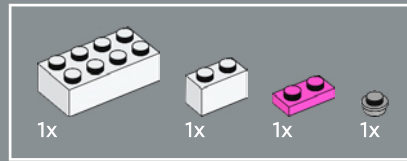
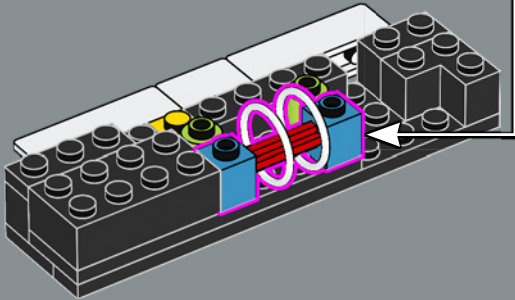
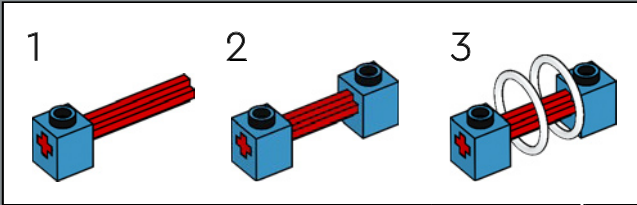

65

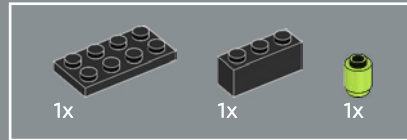
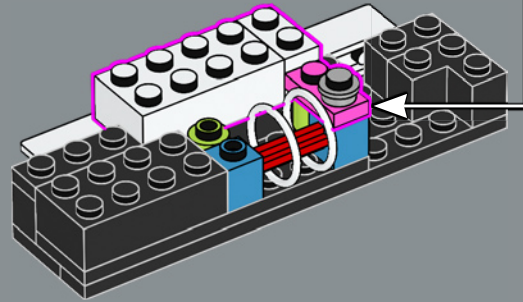
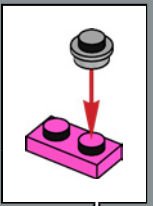

66

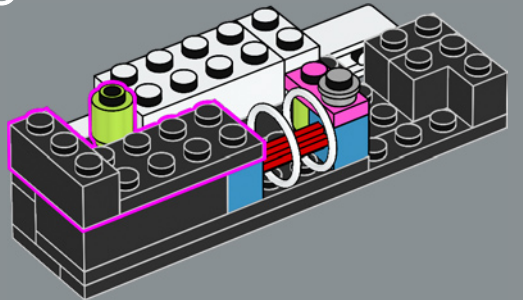

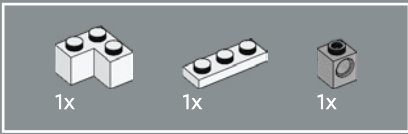

67

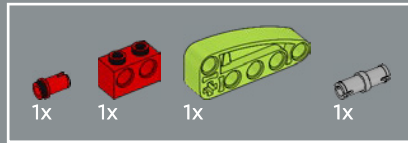
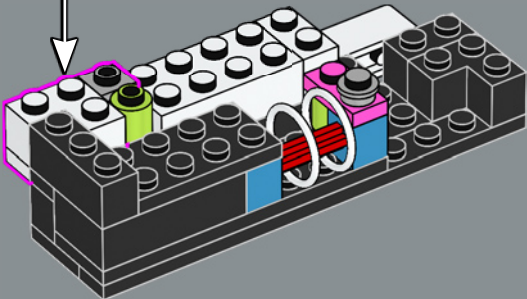
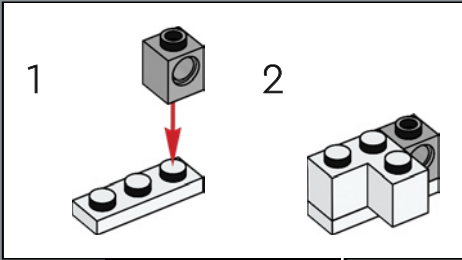

68

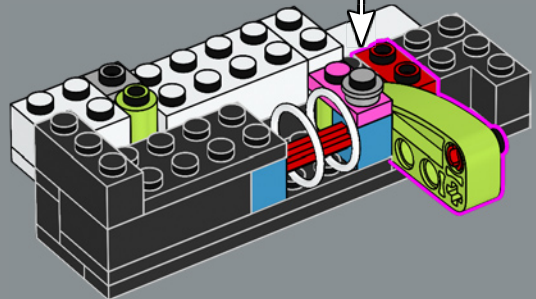
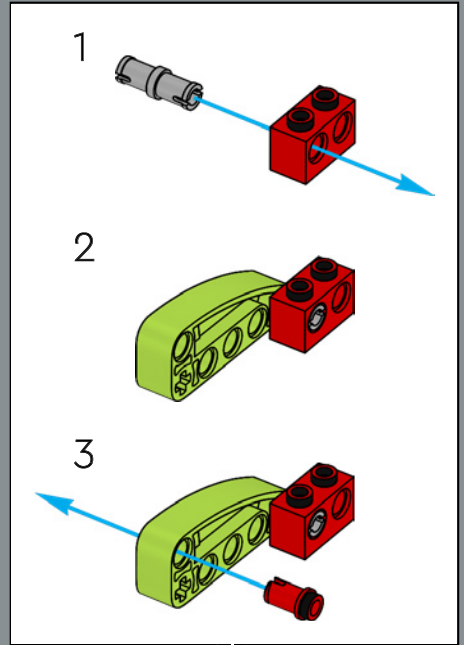

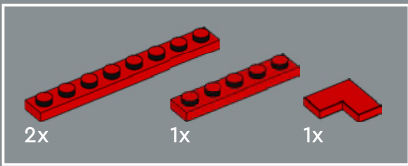

69

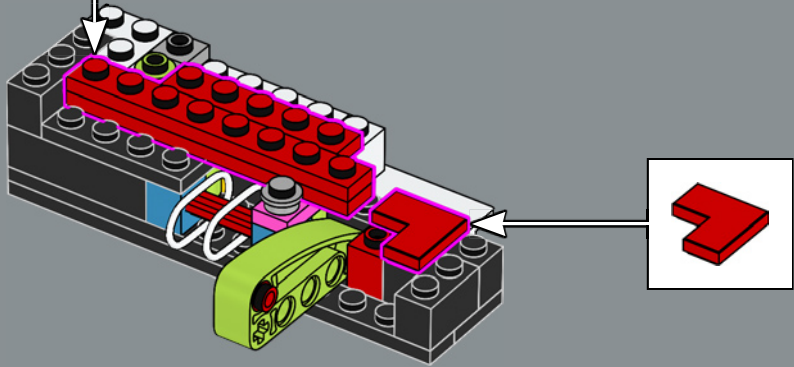
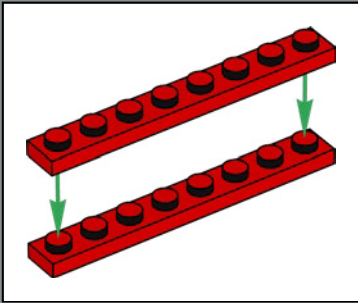

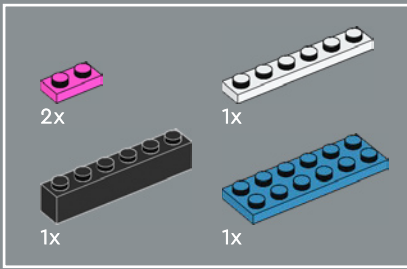

71

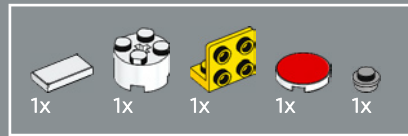
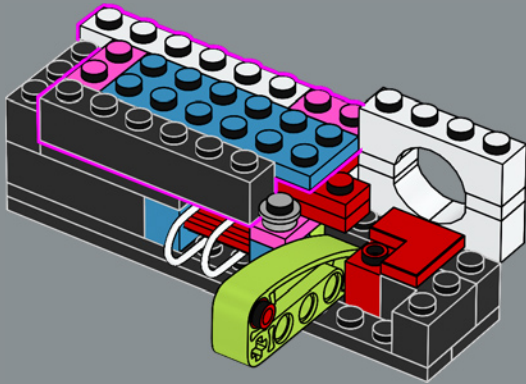

72

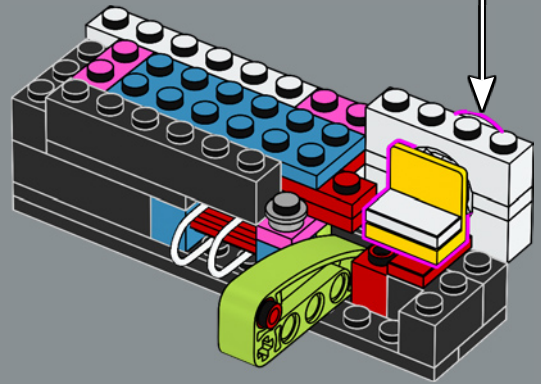
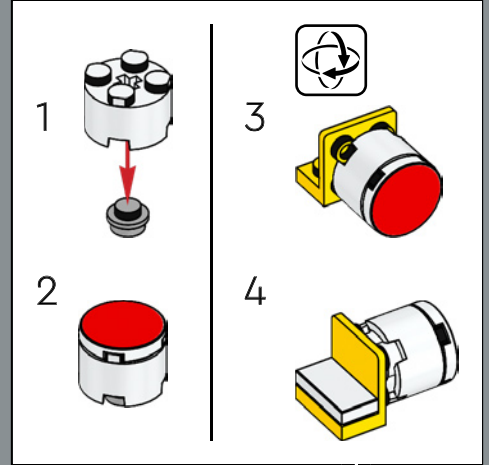

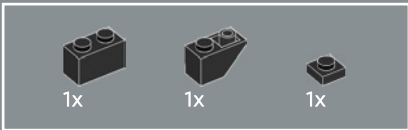

73

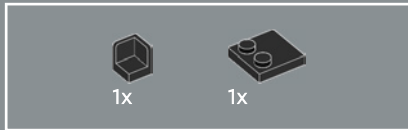
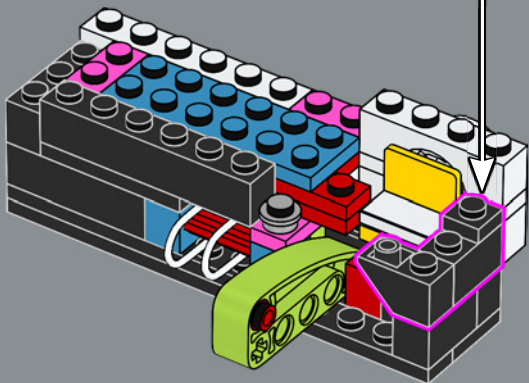
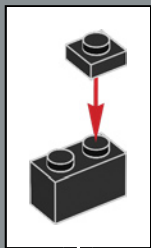

74

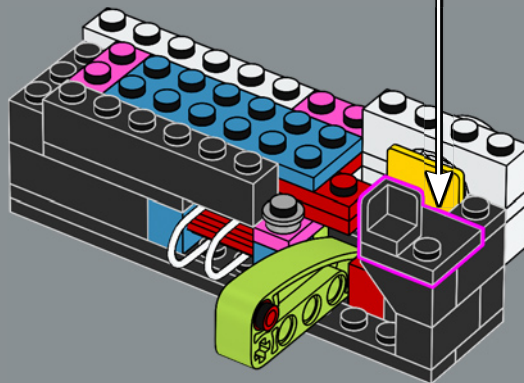
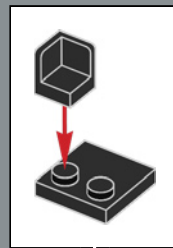

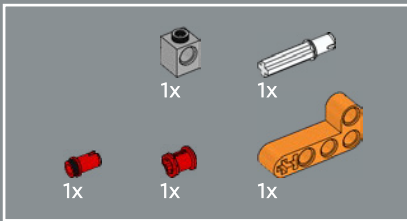

75

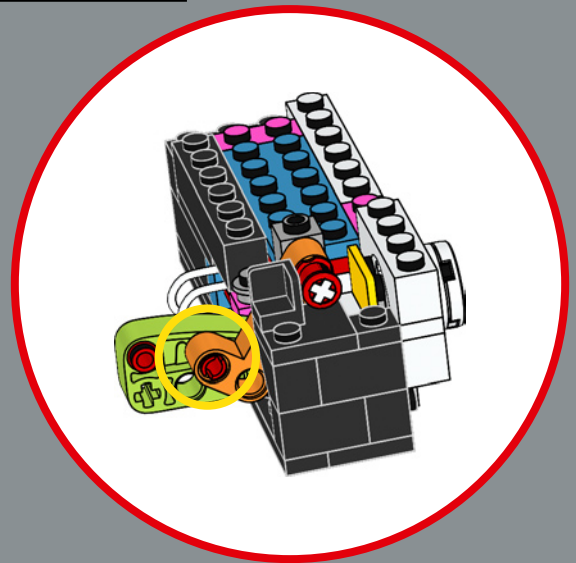
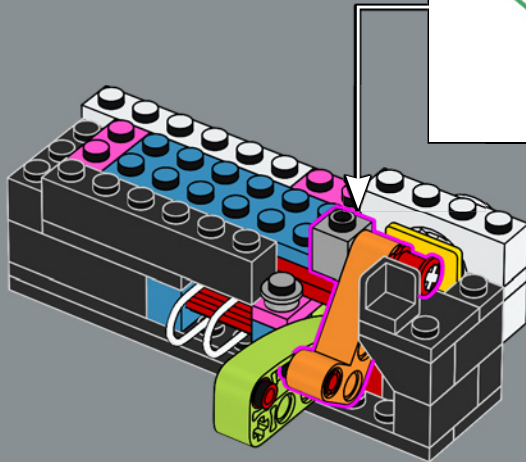
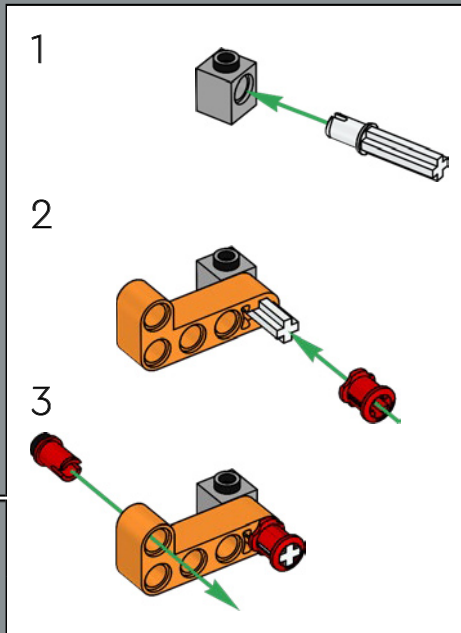

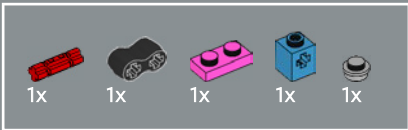

76

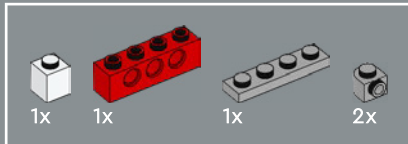
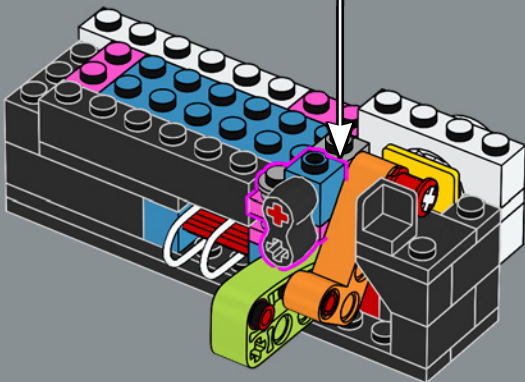
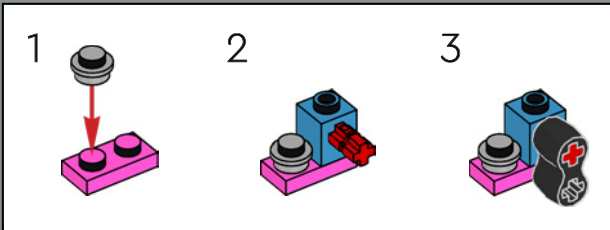

77

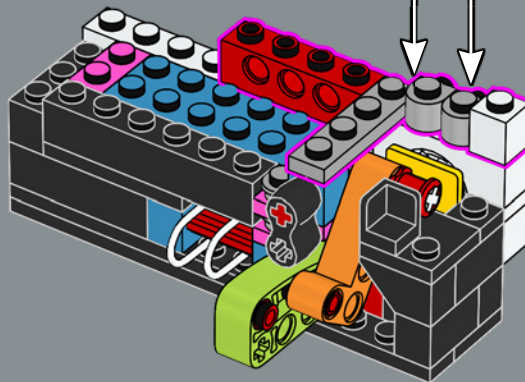
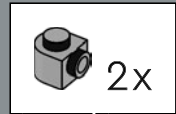

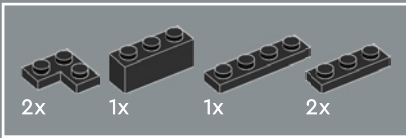

78

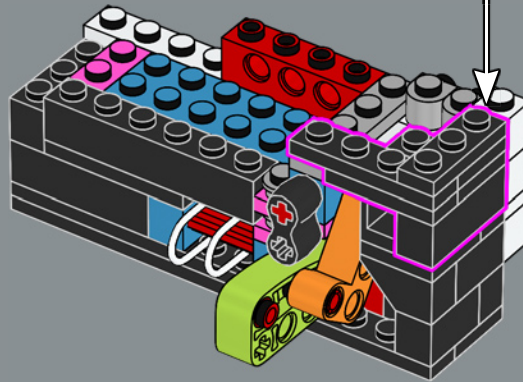
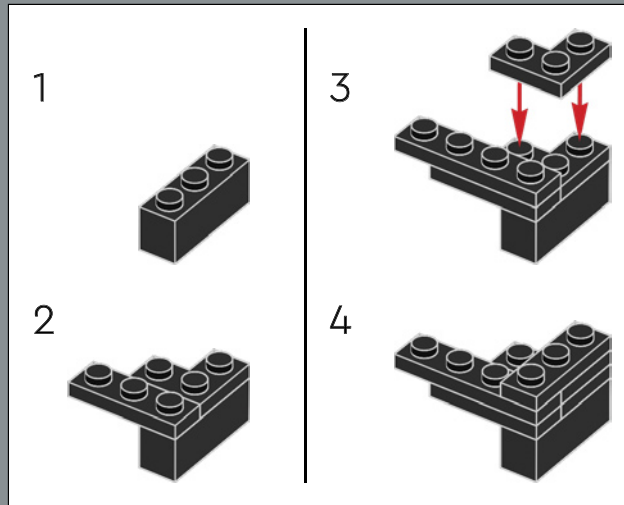

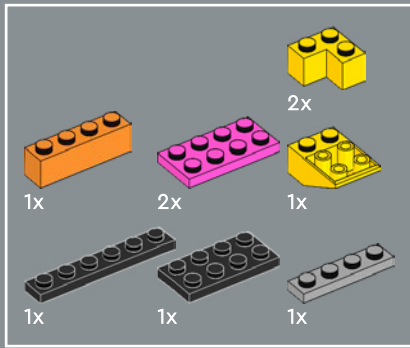

79

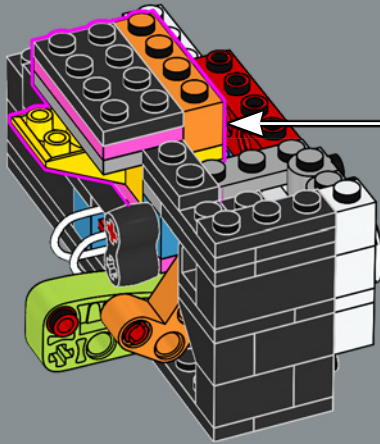
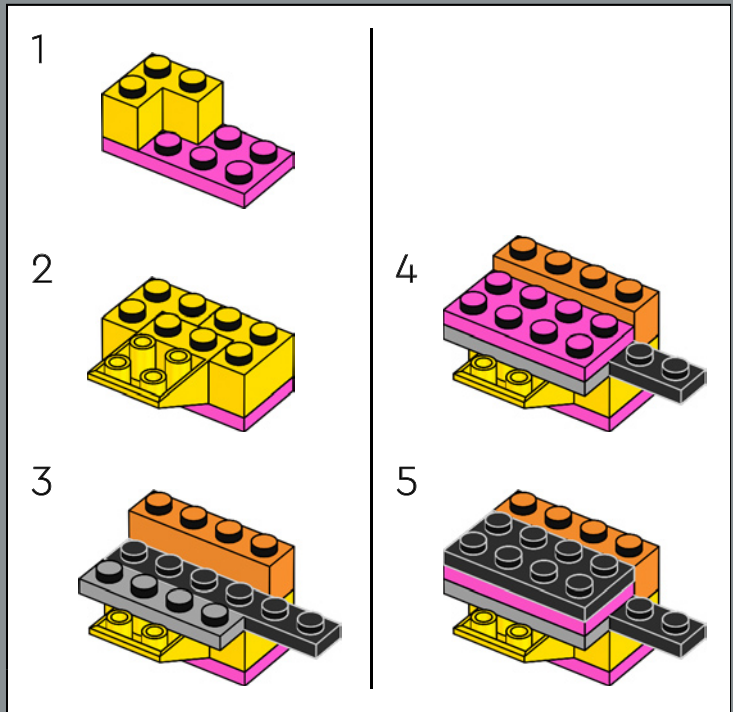

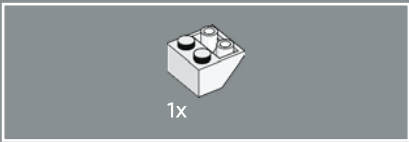

80

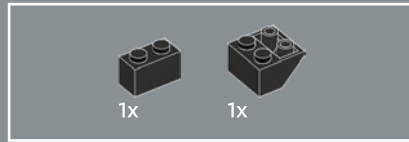
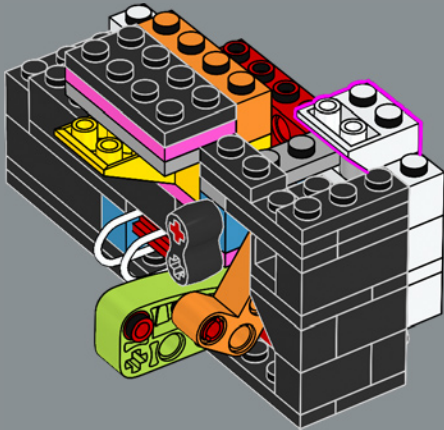

81

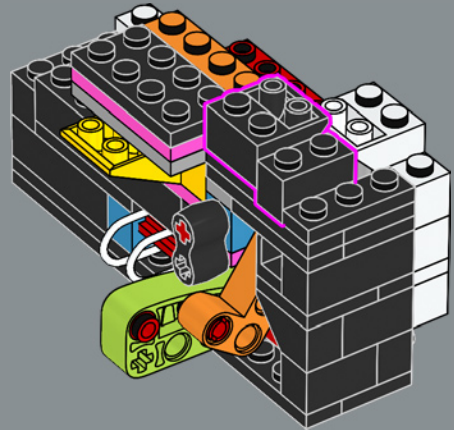

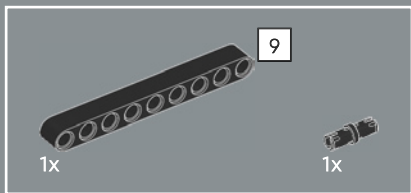

82

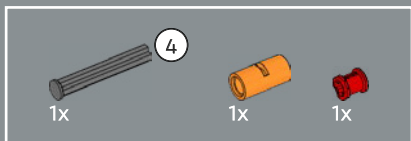
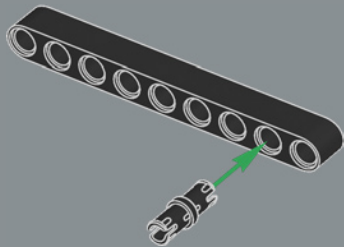

83

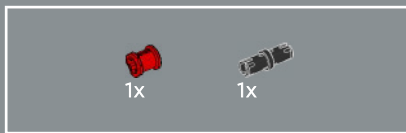
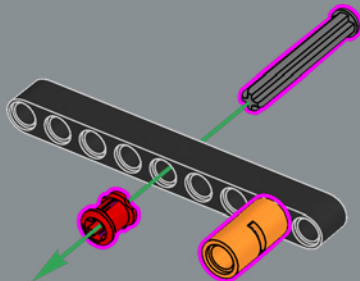

84

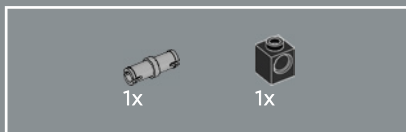
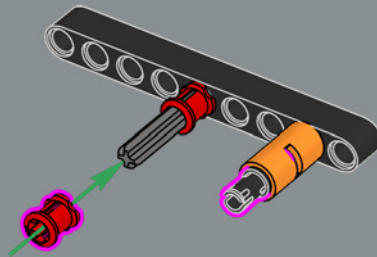

85

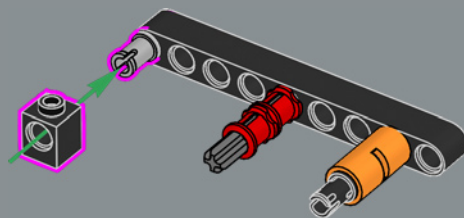

86

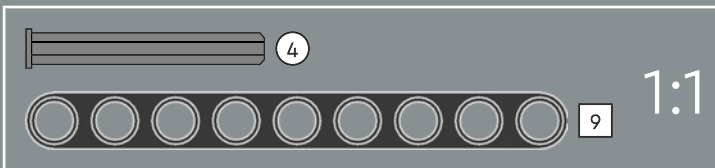
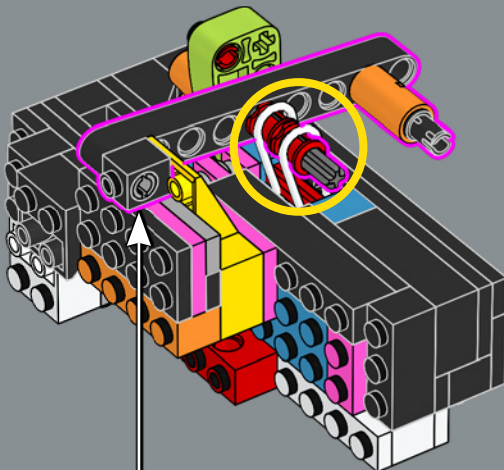

87

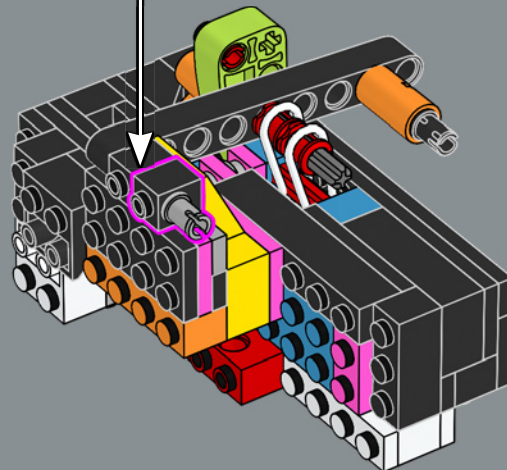
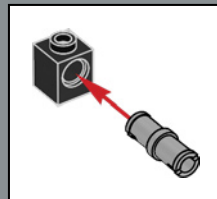
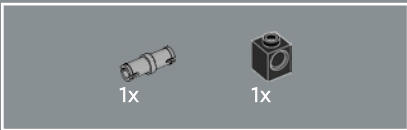

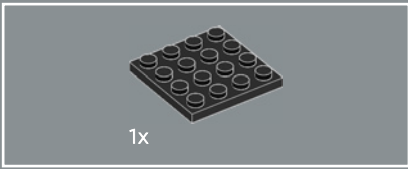

88

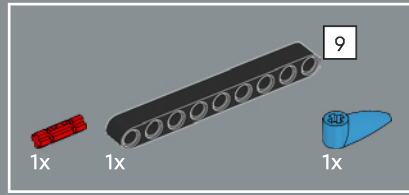
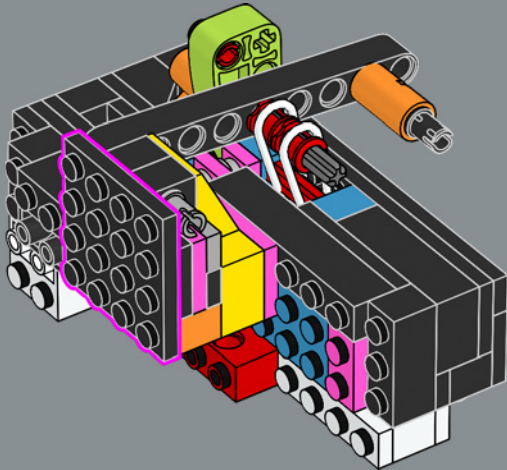

89

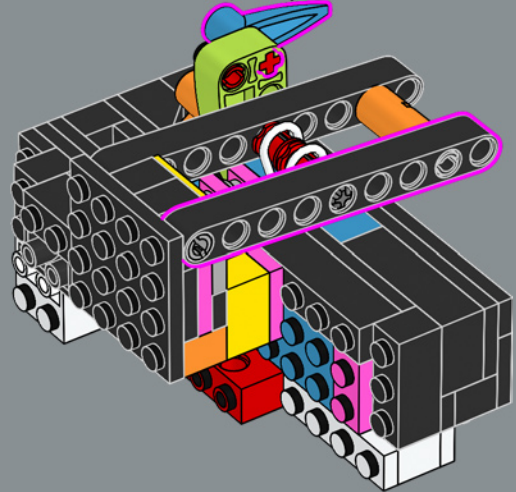
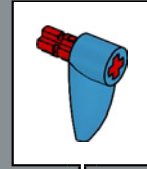

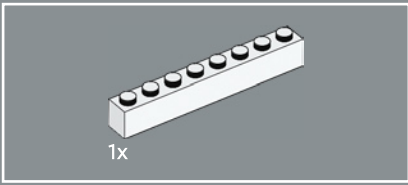

90

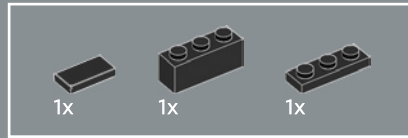
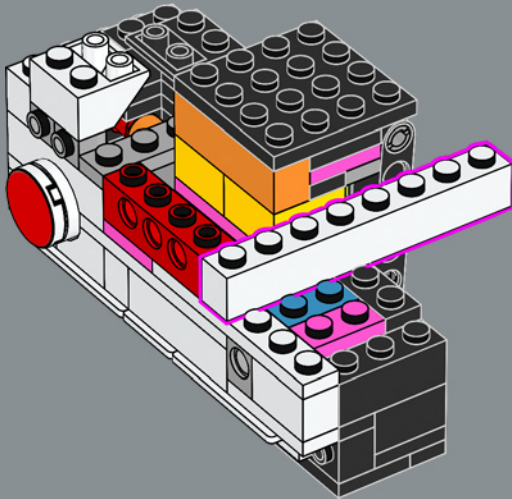

91

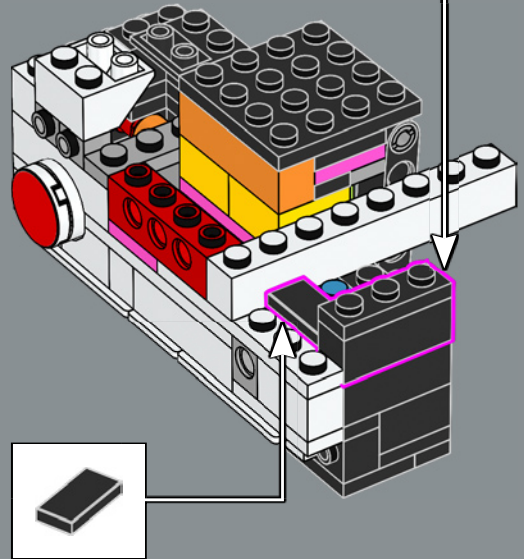
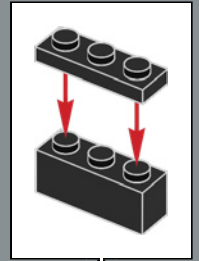

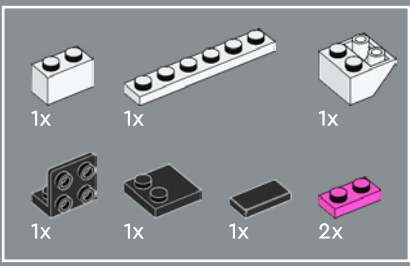

92

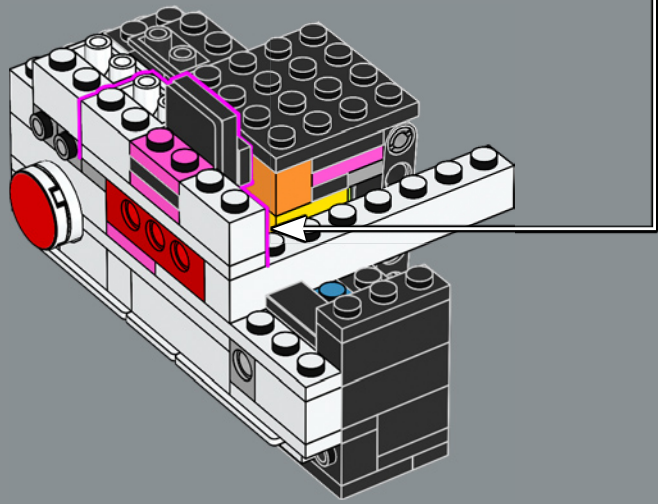
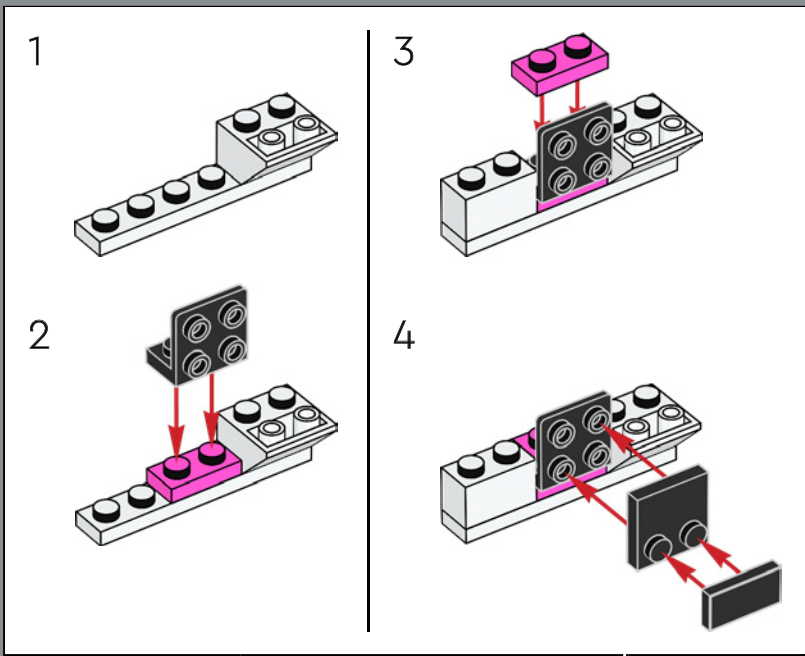

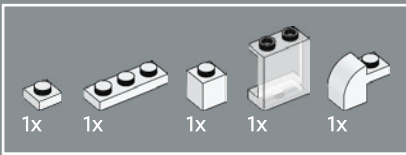

93

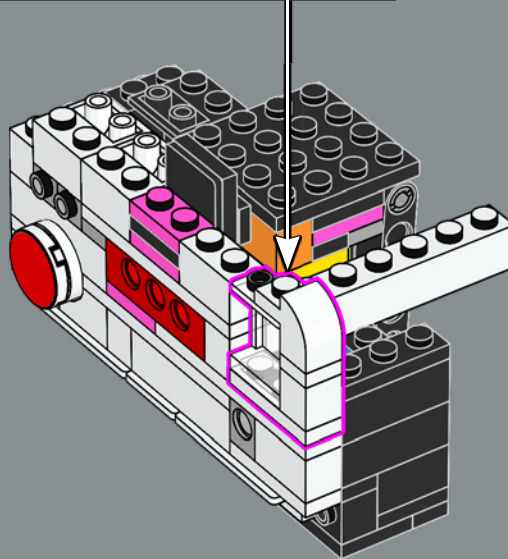
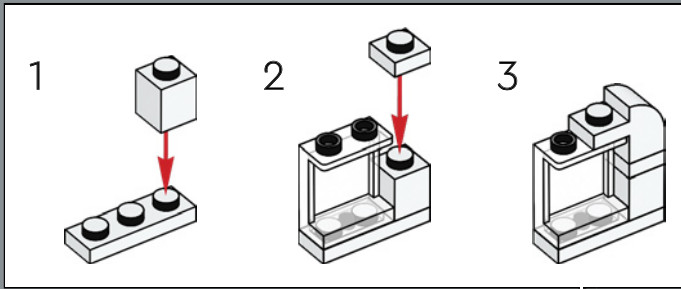

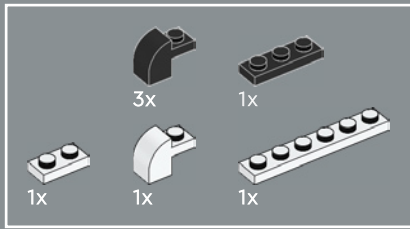

94

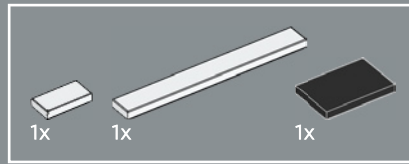
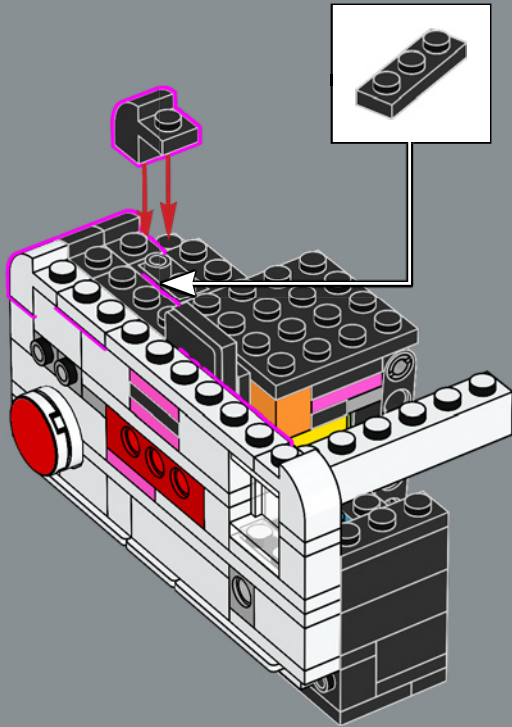

95

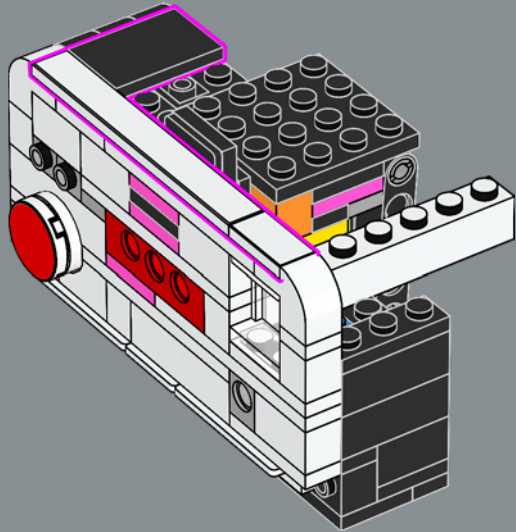



96

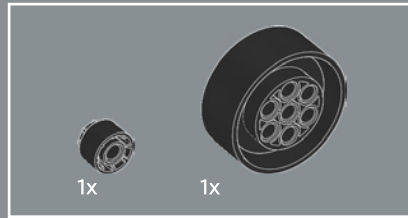
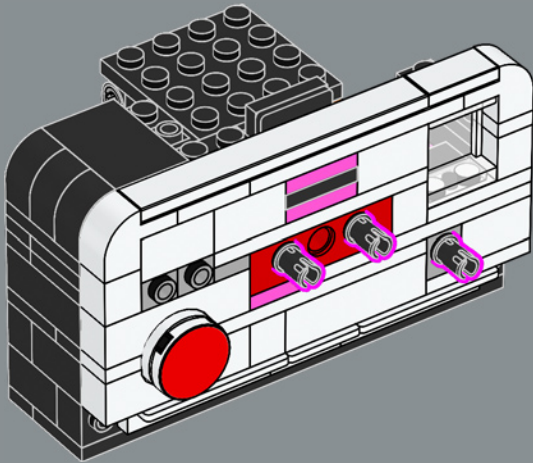

97

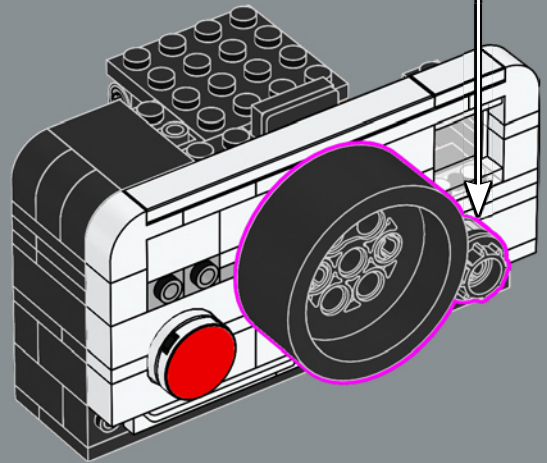
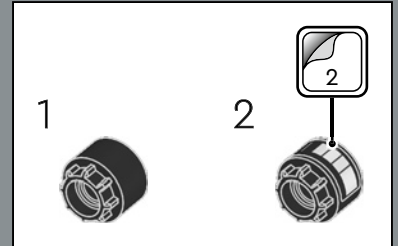

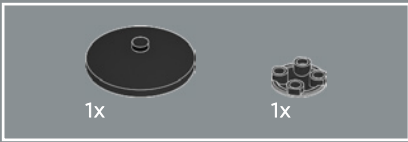

98

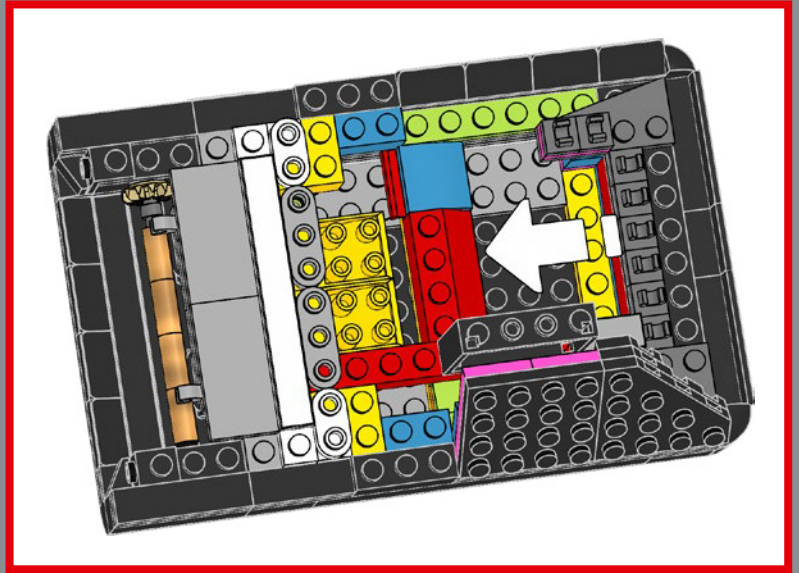
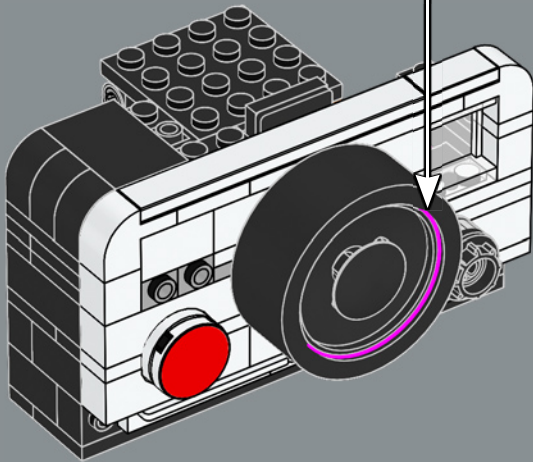
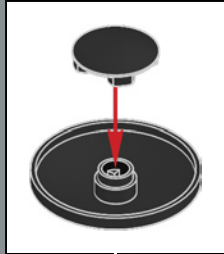

99

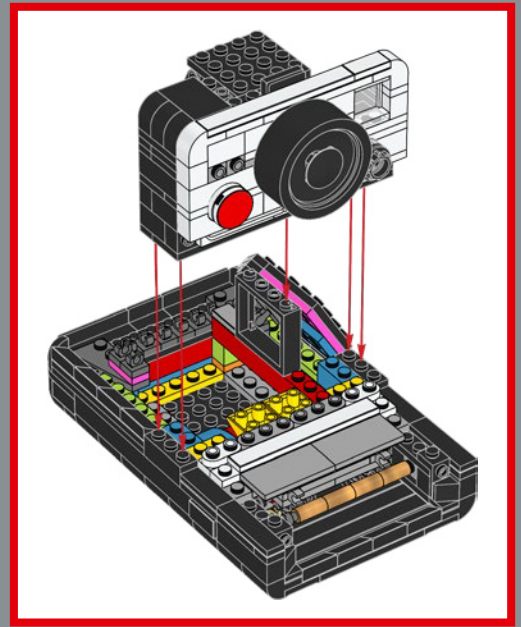
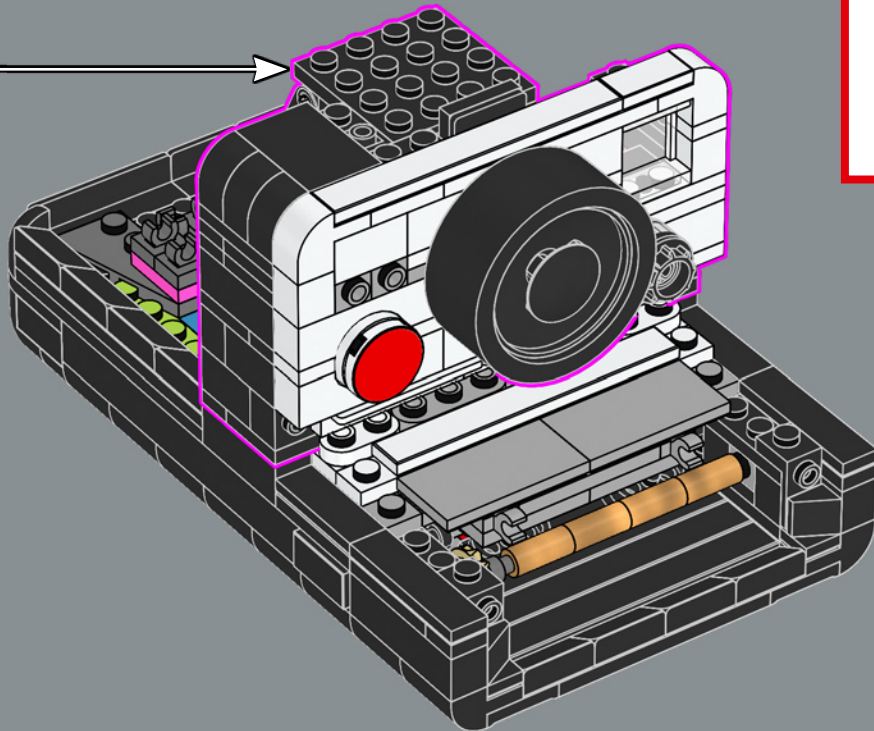

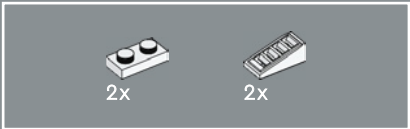

100

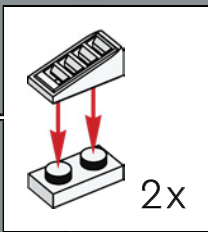
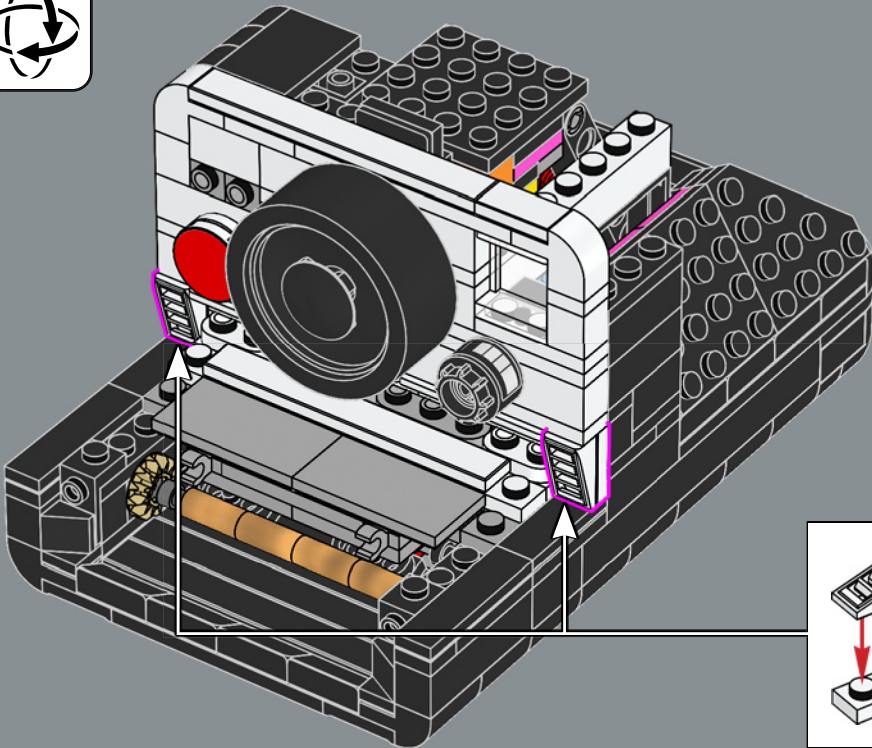

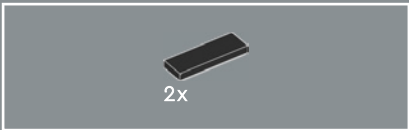

101

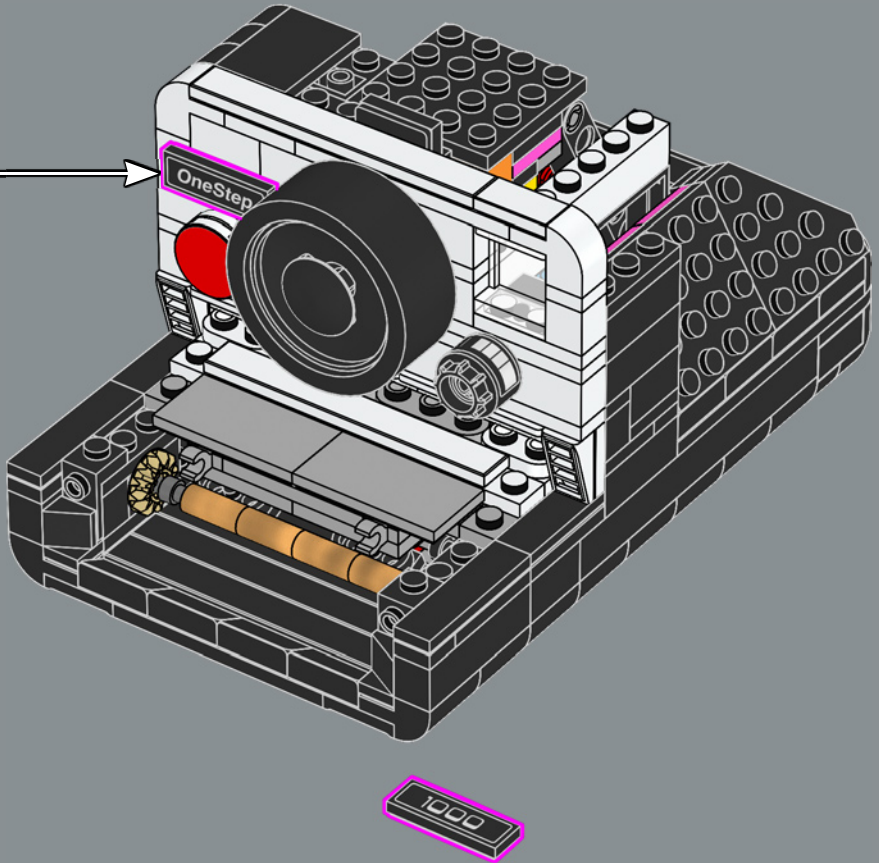
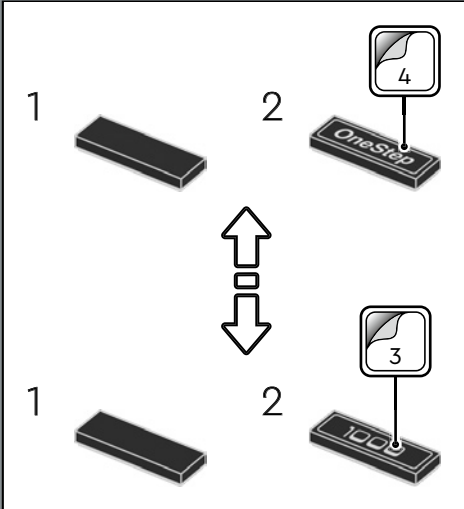

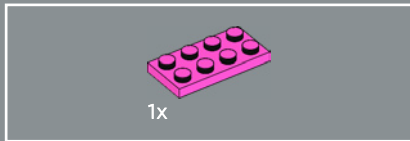
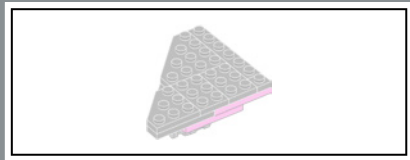

102

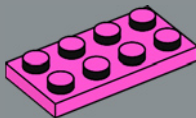

103

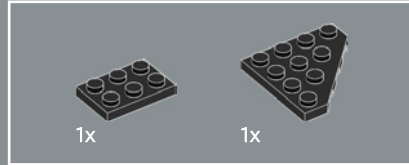
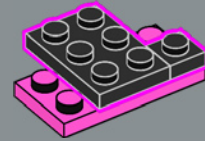

104

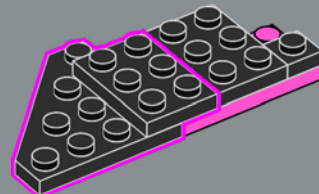

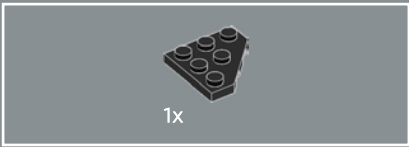

105

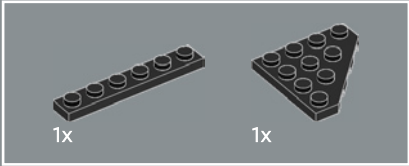
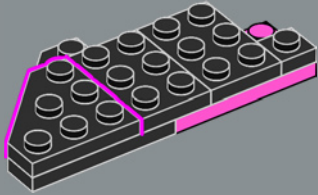

106

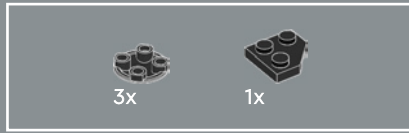
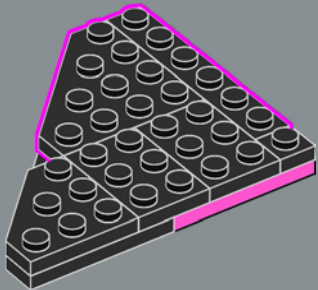

107

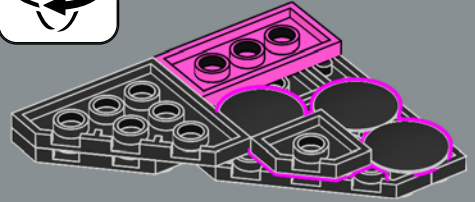

108

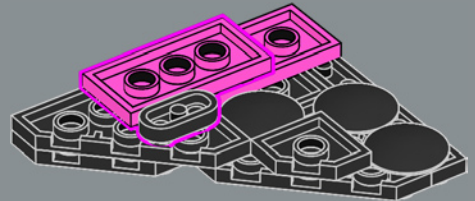

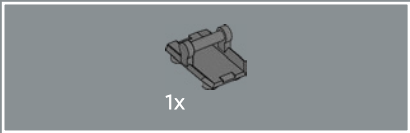

109

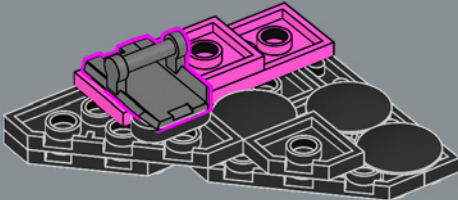

110

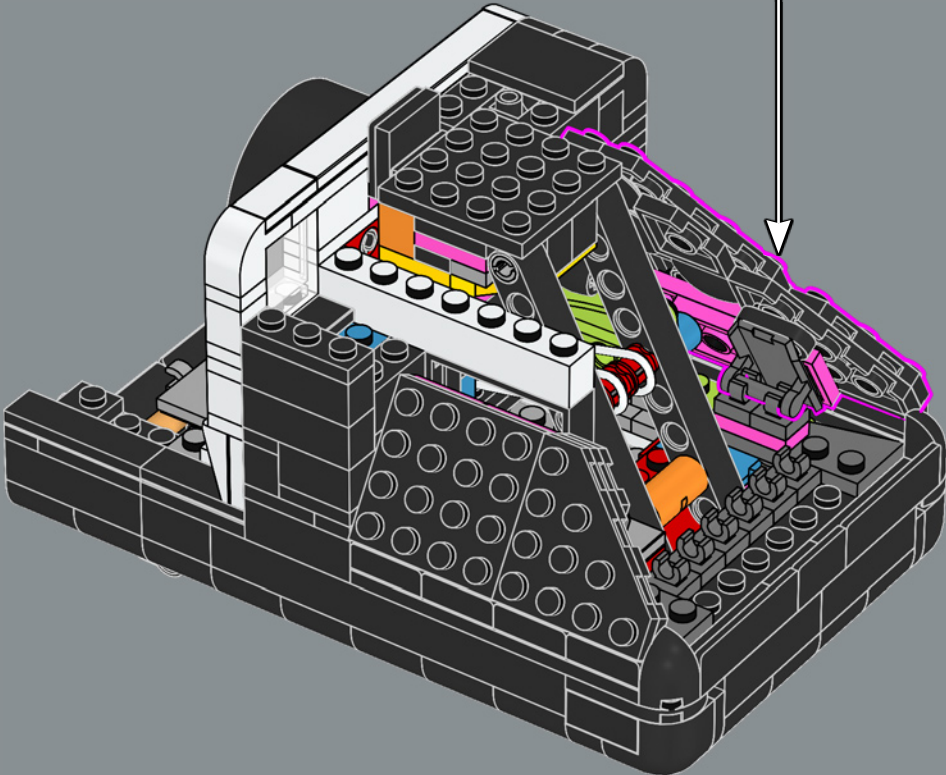

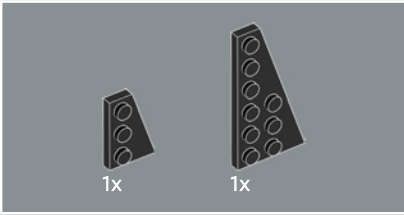
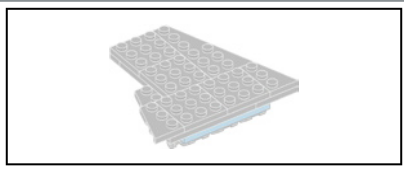

111

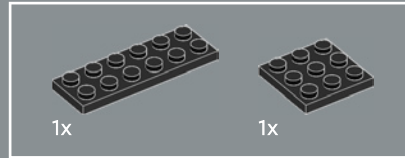
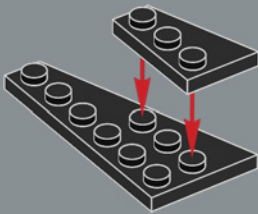

112

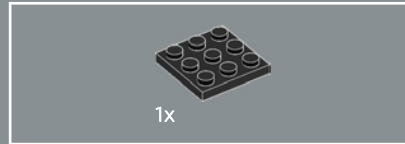
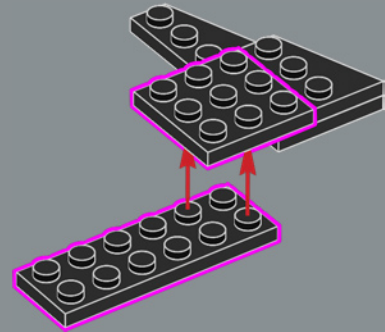

113

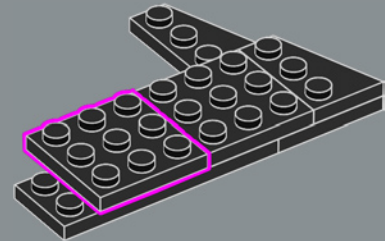

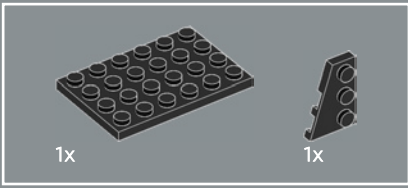

114

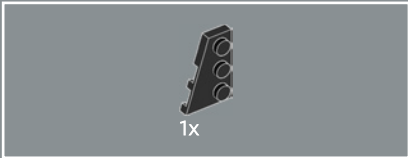
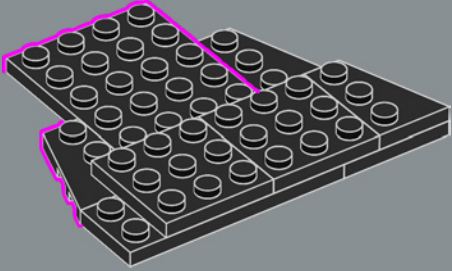

115

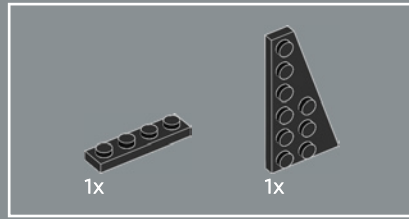
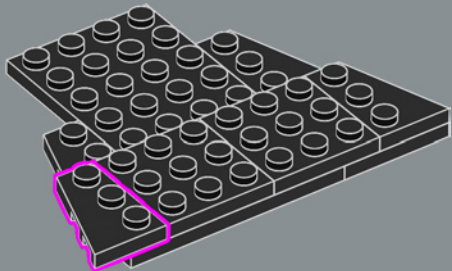

116

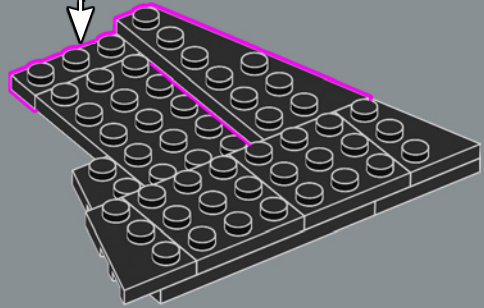
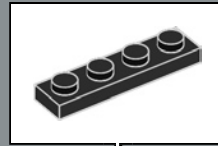

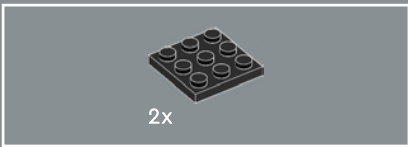

117

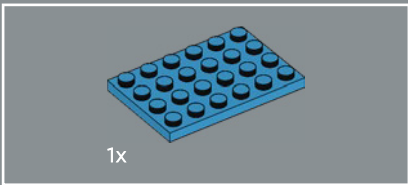
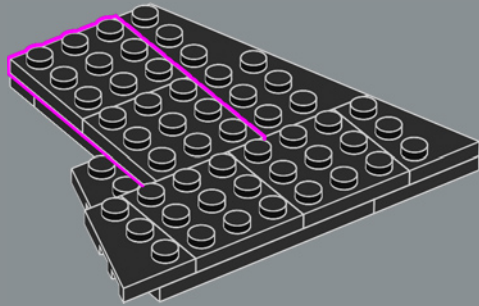

118

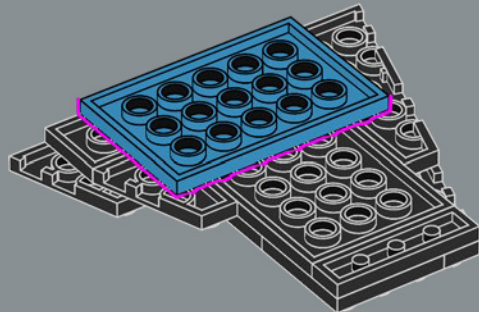

119

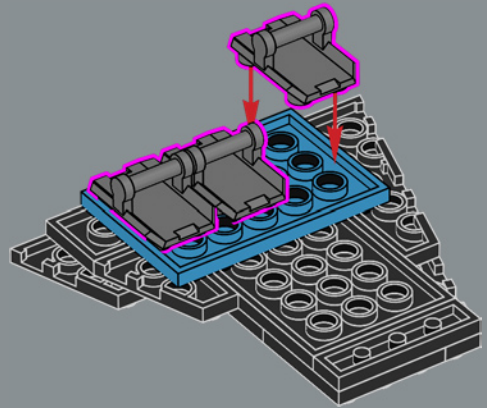

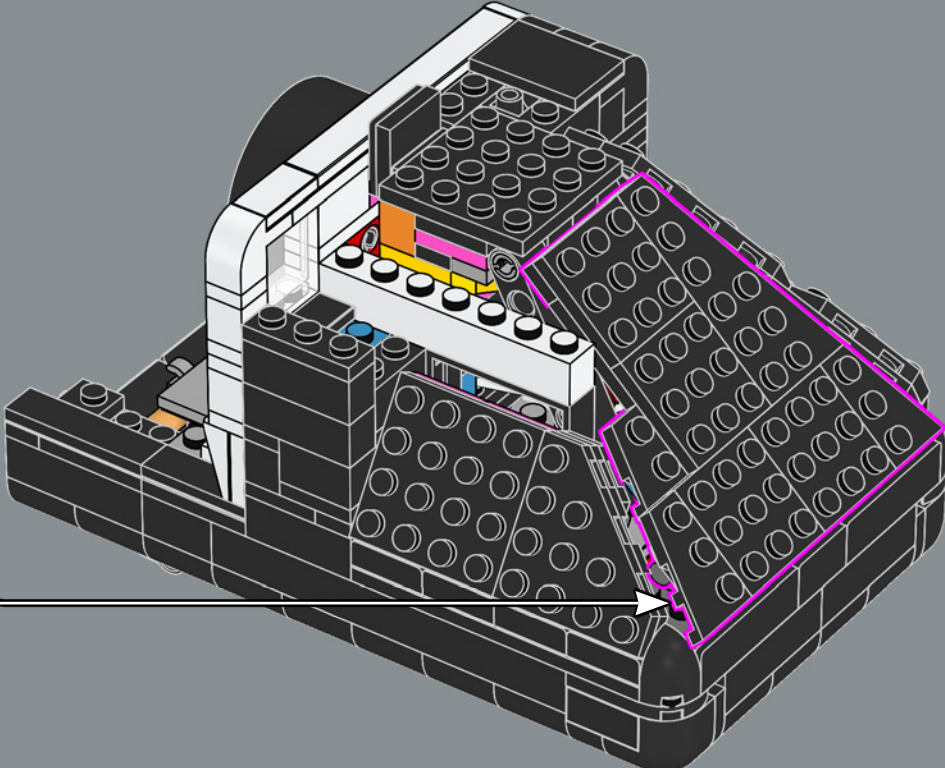

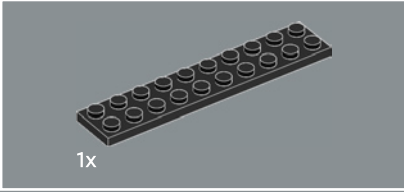
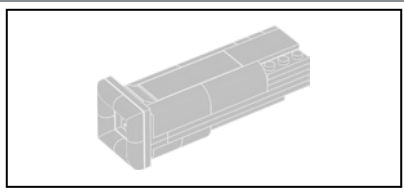

1x

121

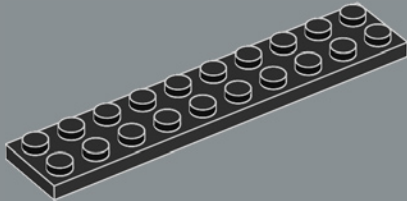

1x

1x

122

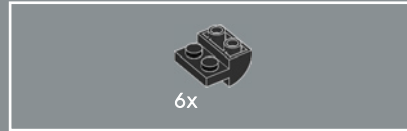
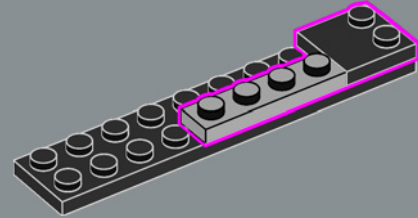

6x

123

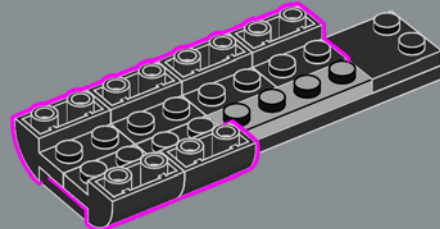

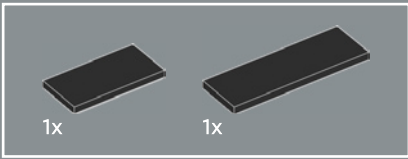

124

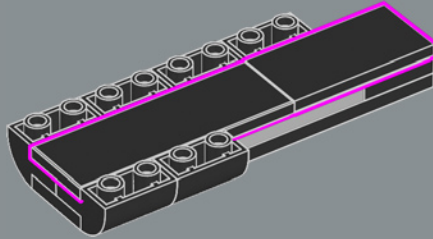

125

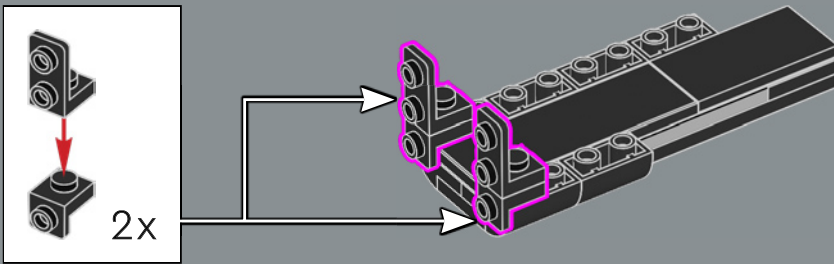

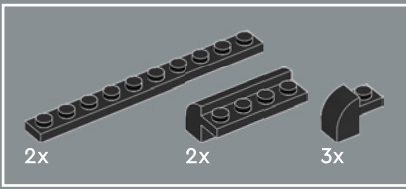

126

1

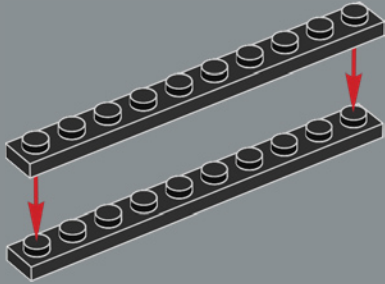

2

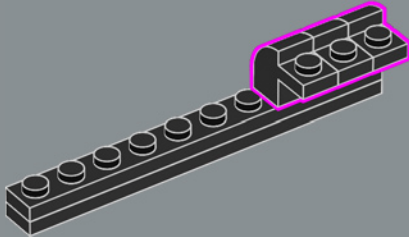

3

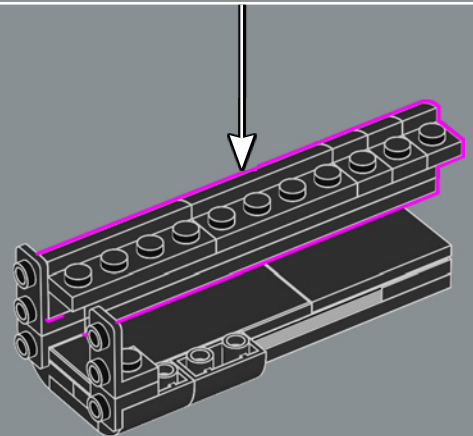
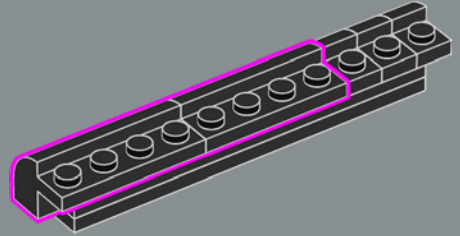

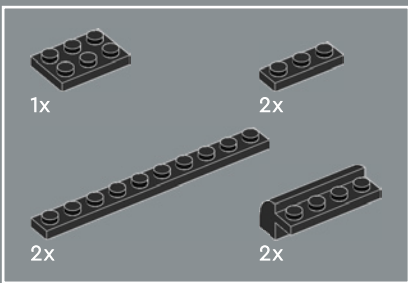

127

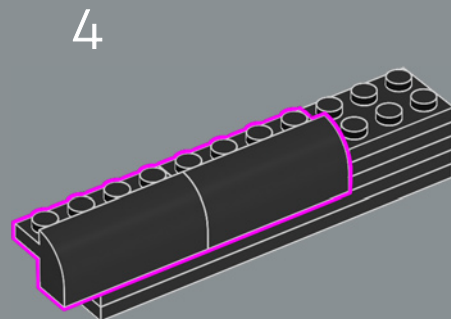
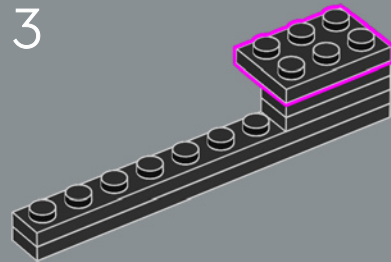
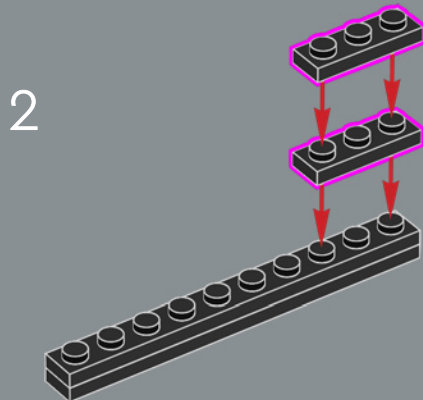
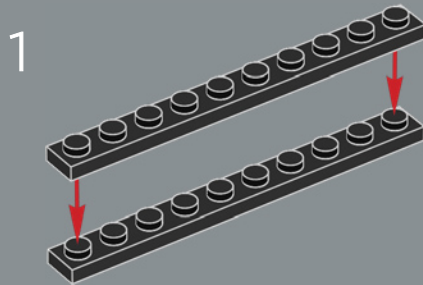

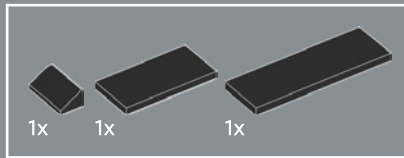

128

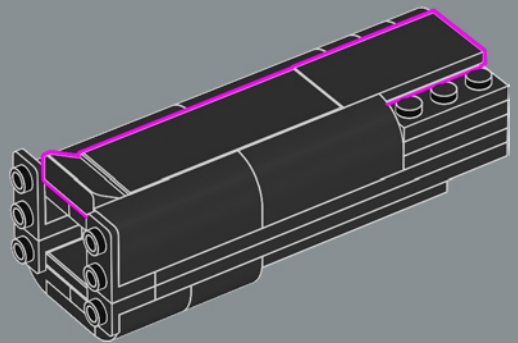
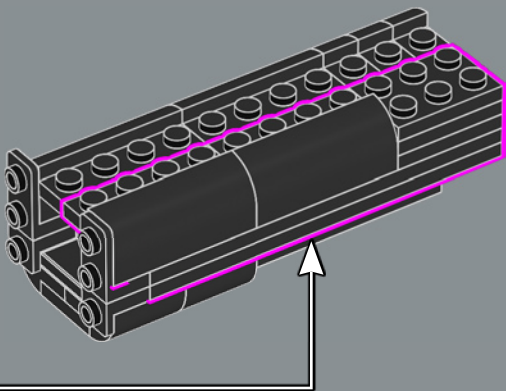

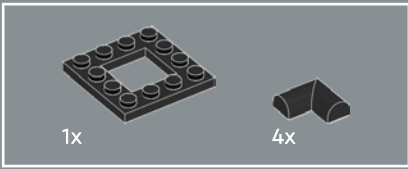

129

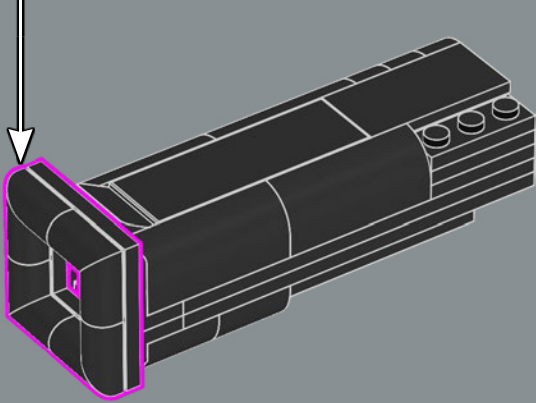
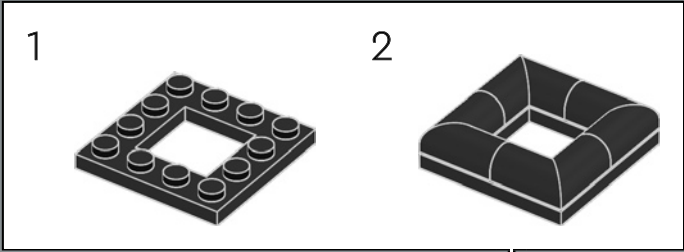

130

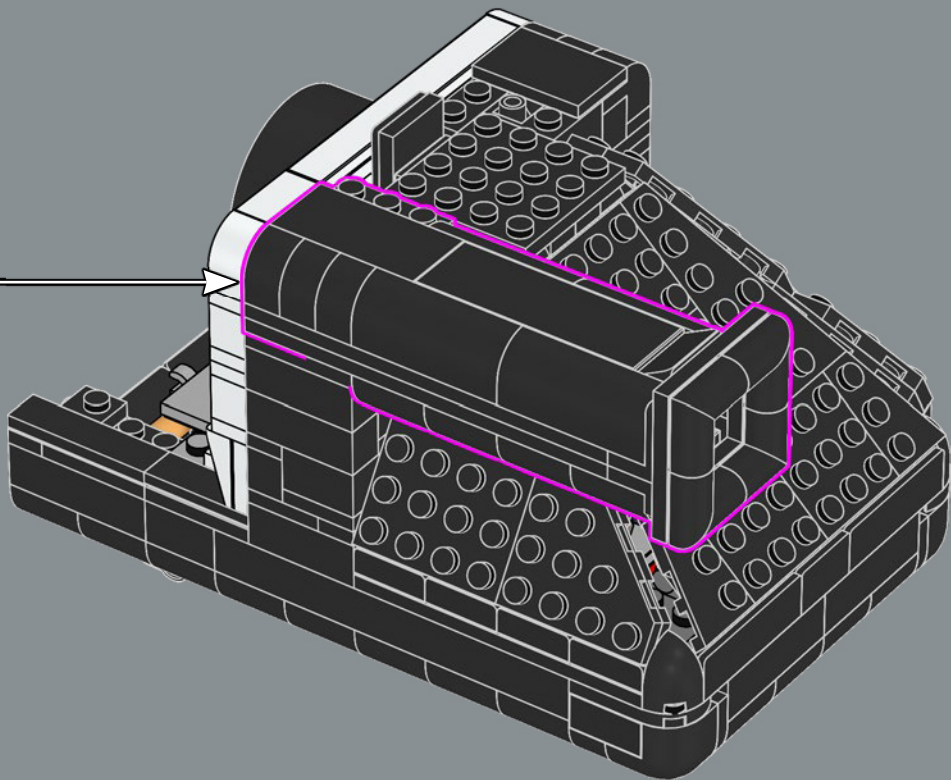

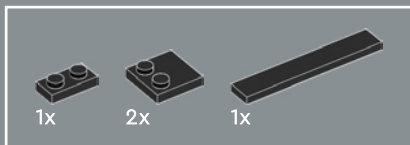

131

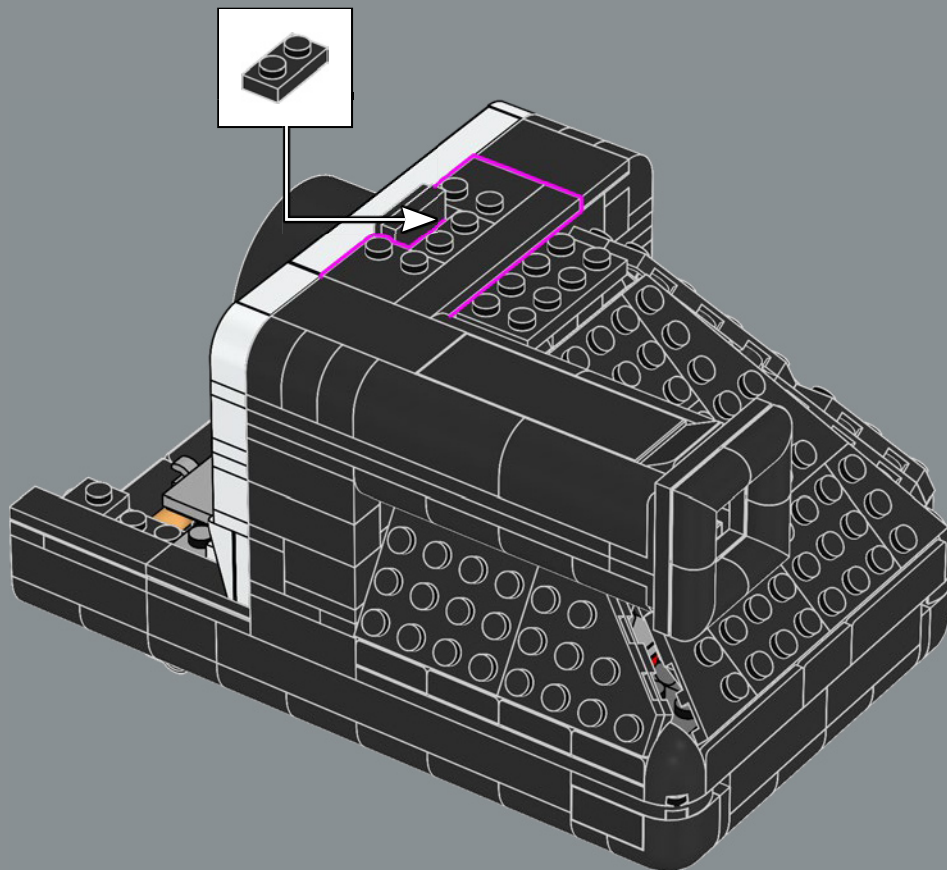

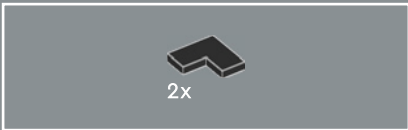

132

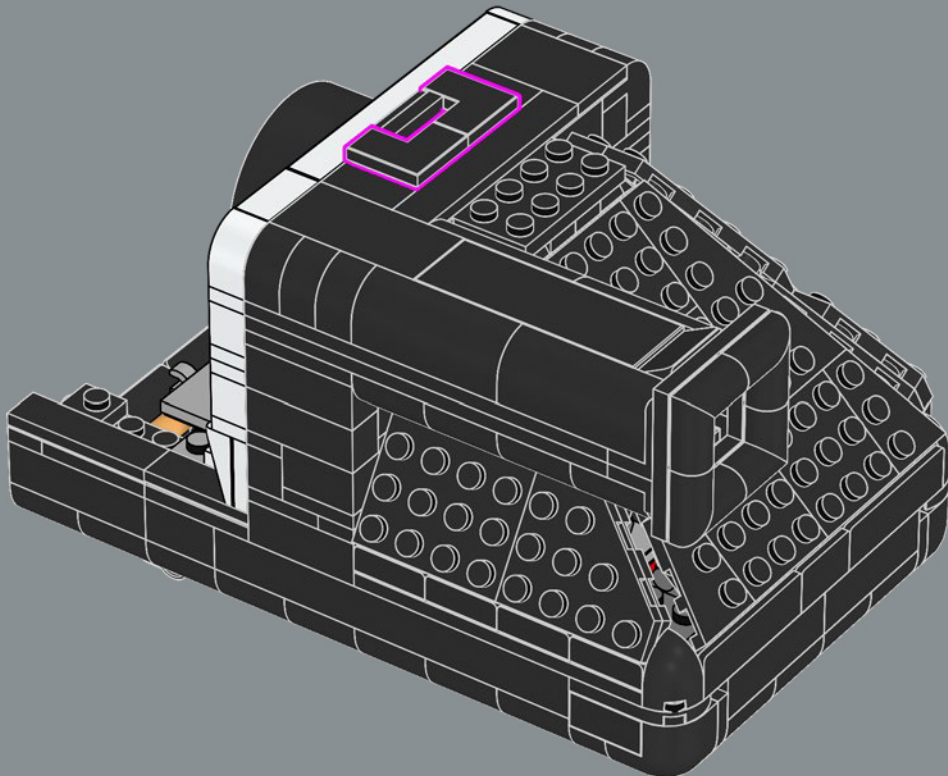

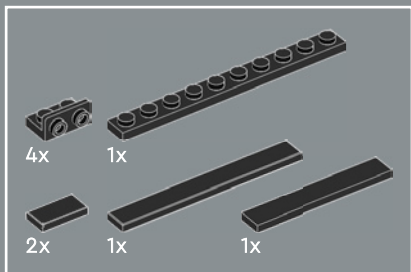

133

1

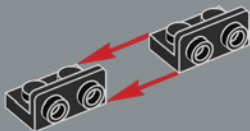

2

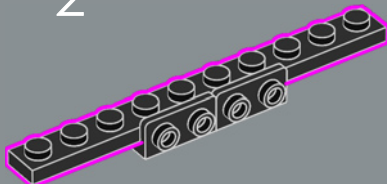

3

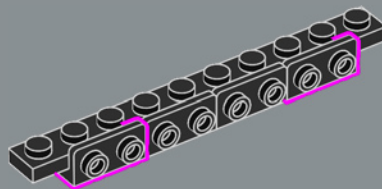

4

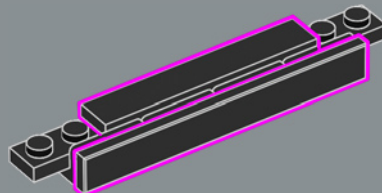



5

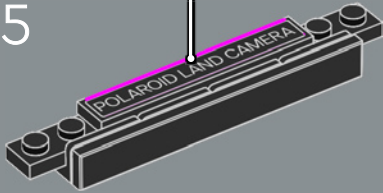

6

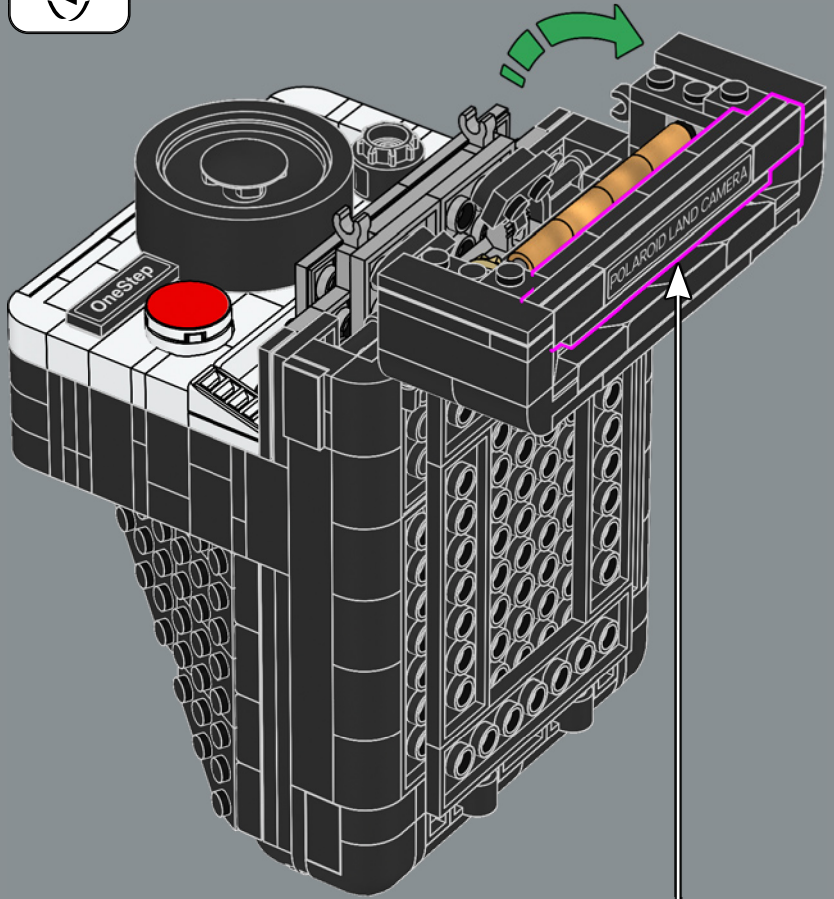
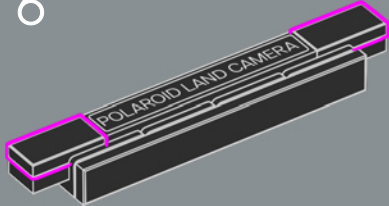

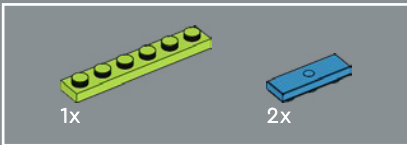
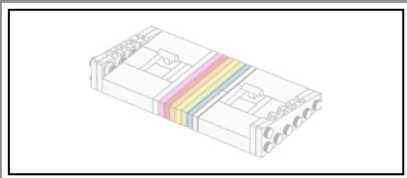

134

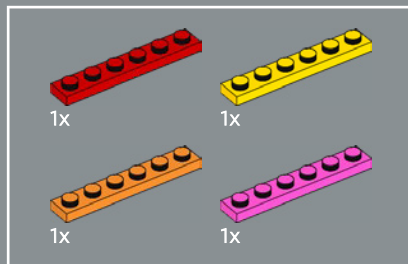
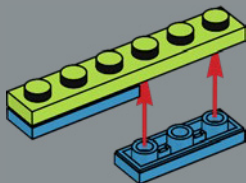

135

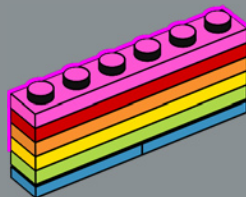

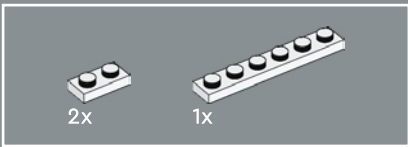

136

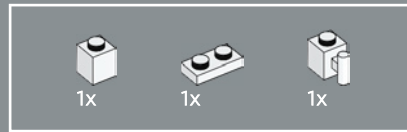
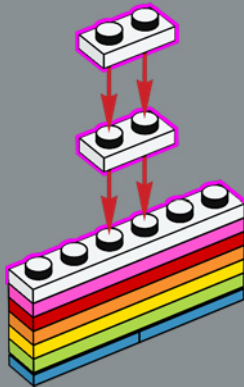

137

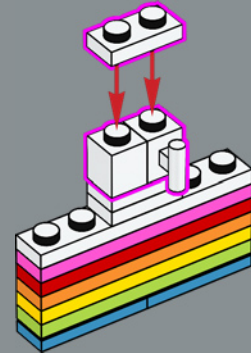

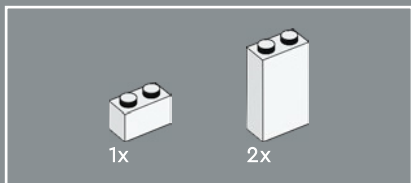

138

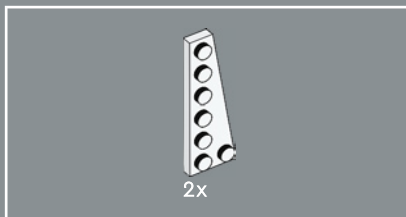
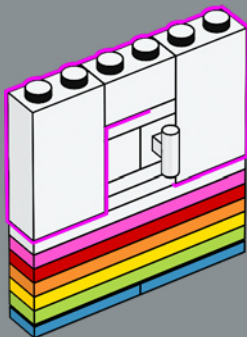

139

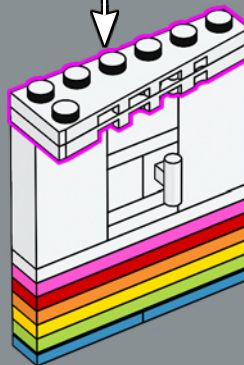
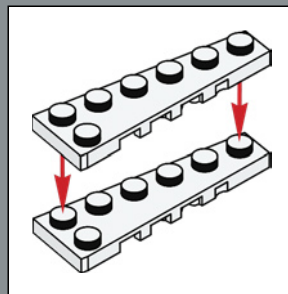



140

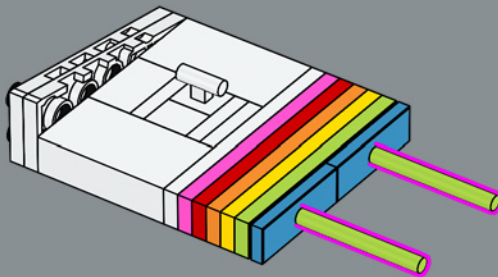

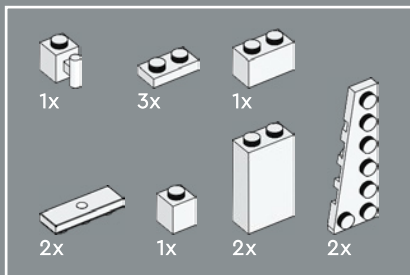

141

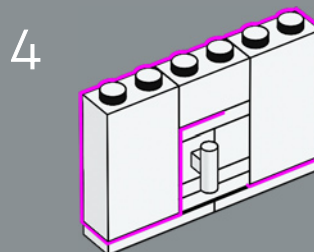
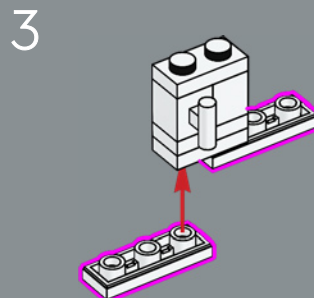
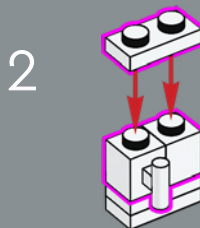
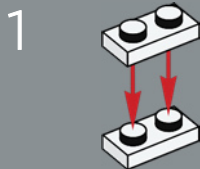

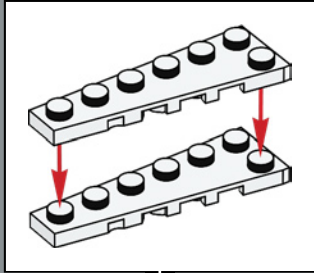

5

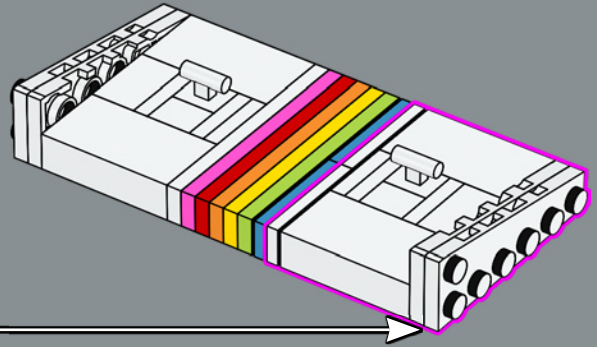
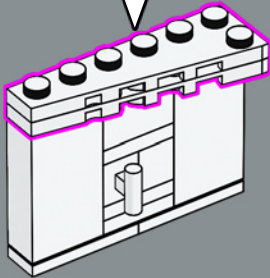

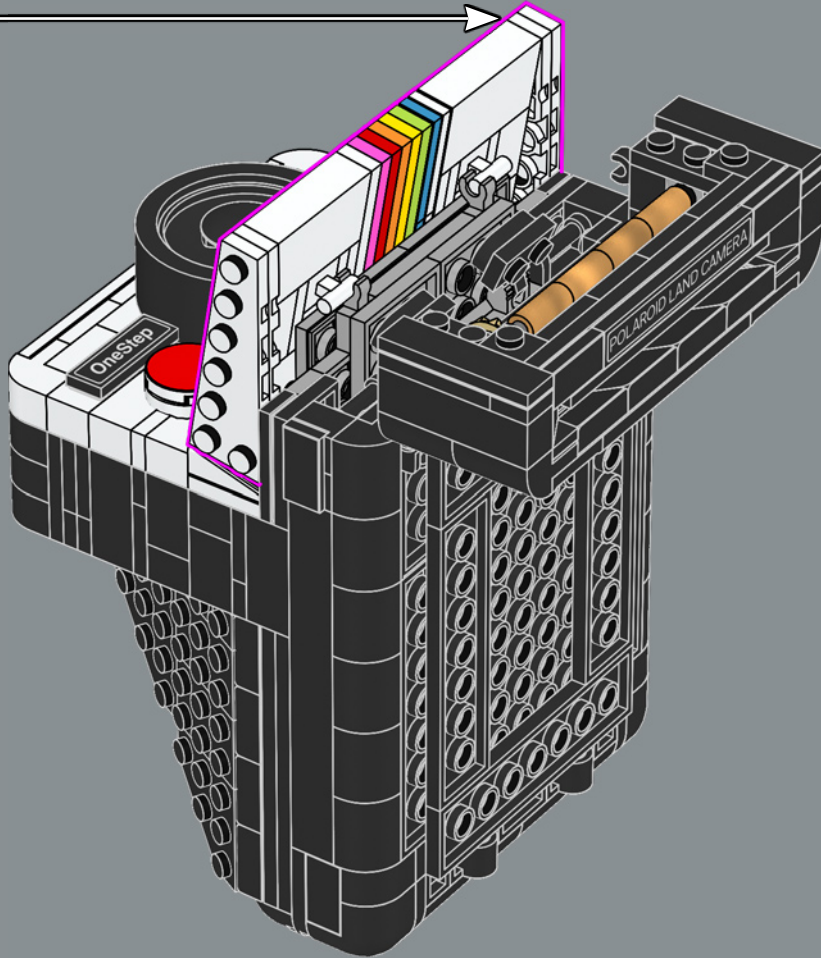

143

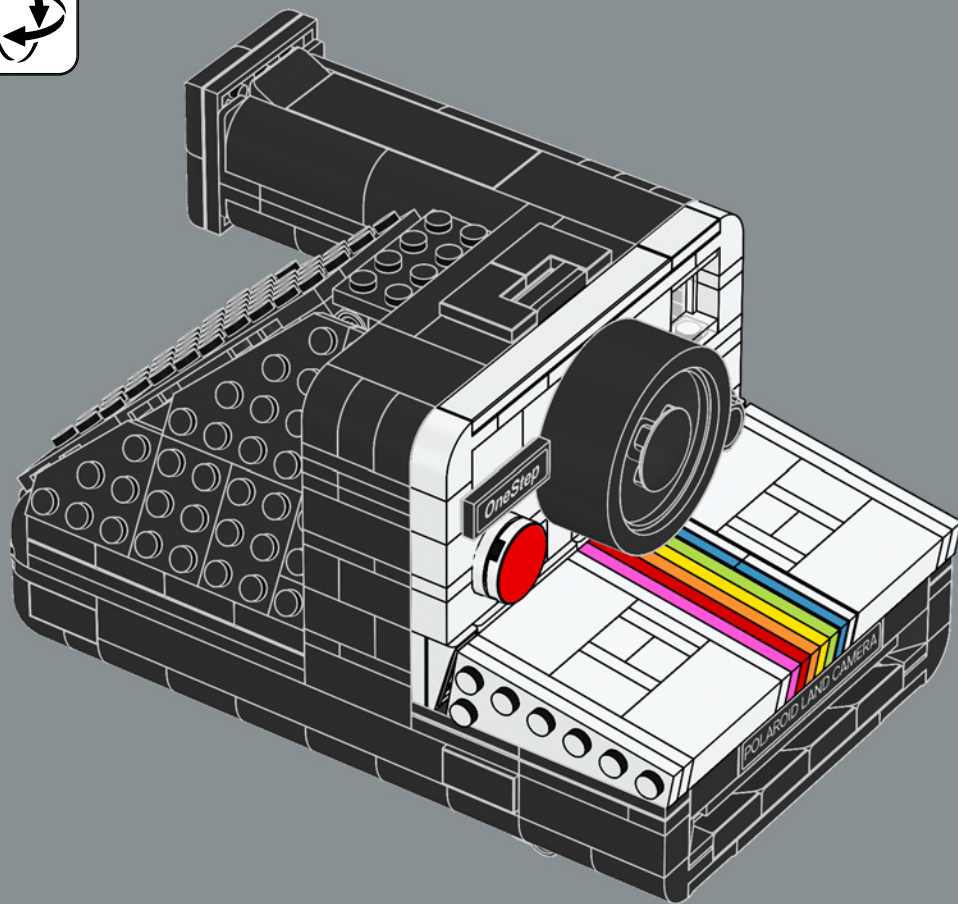

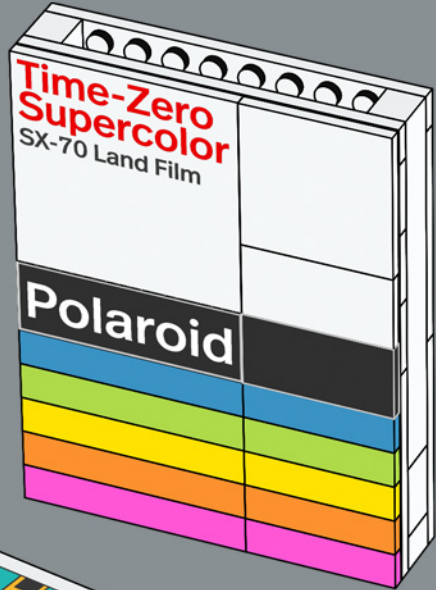

144

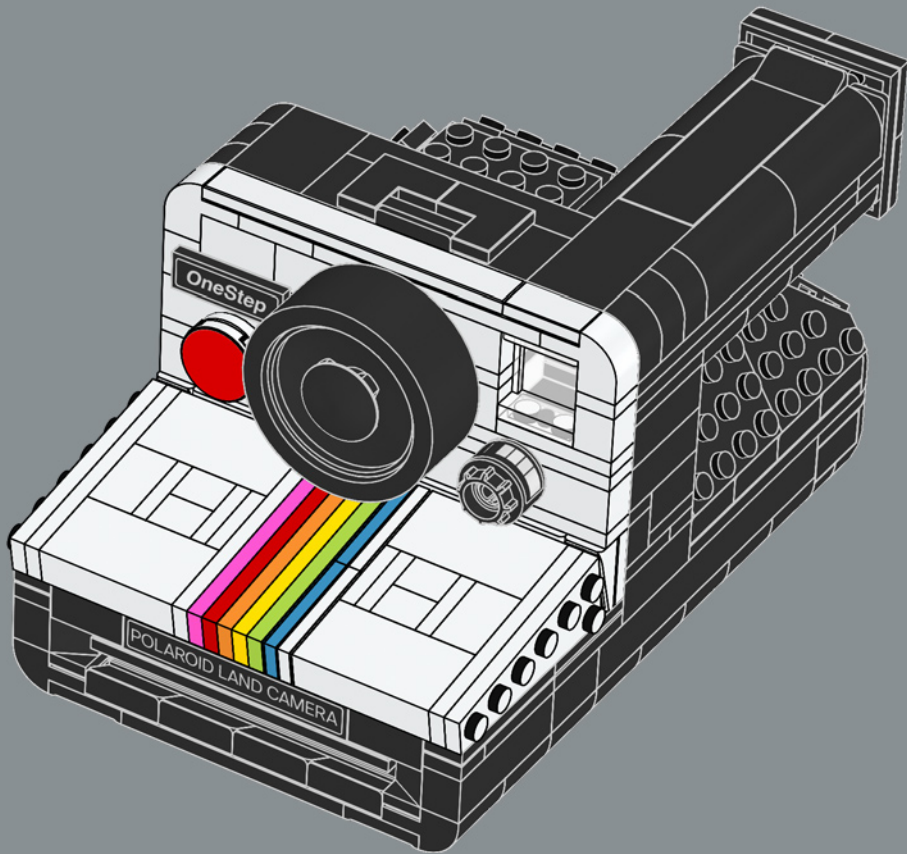



1

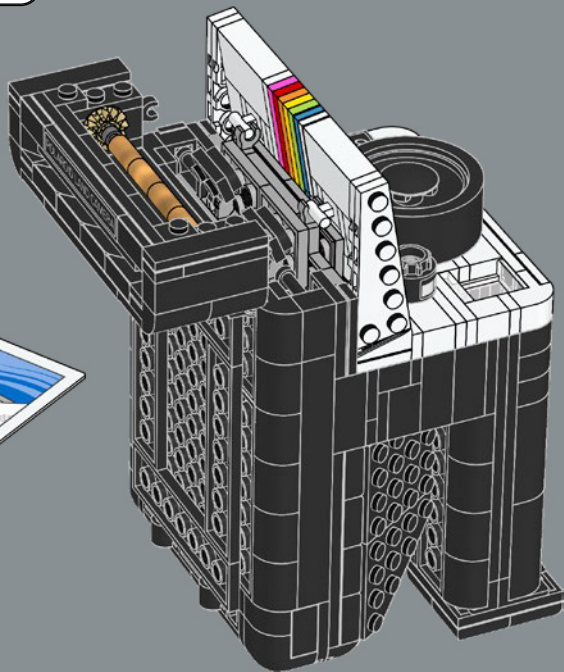



2

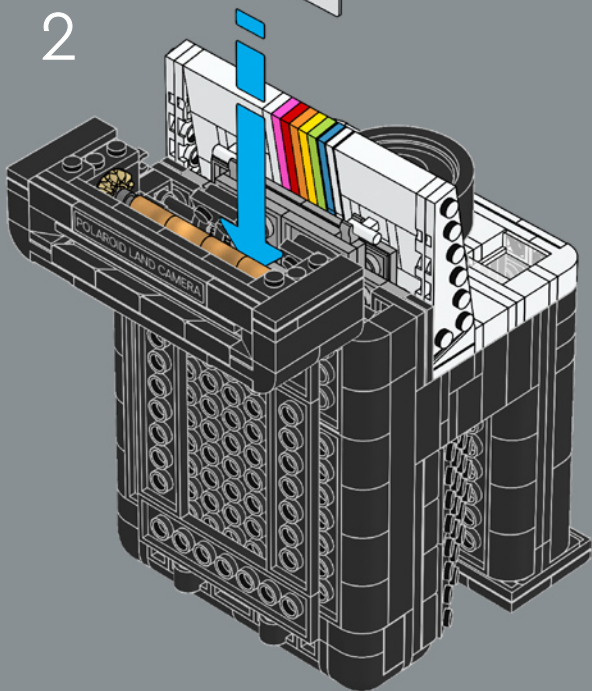

3

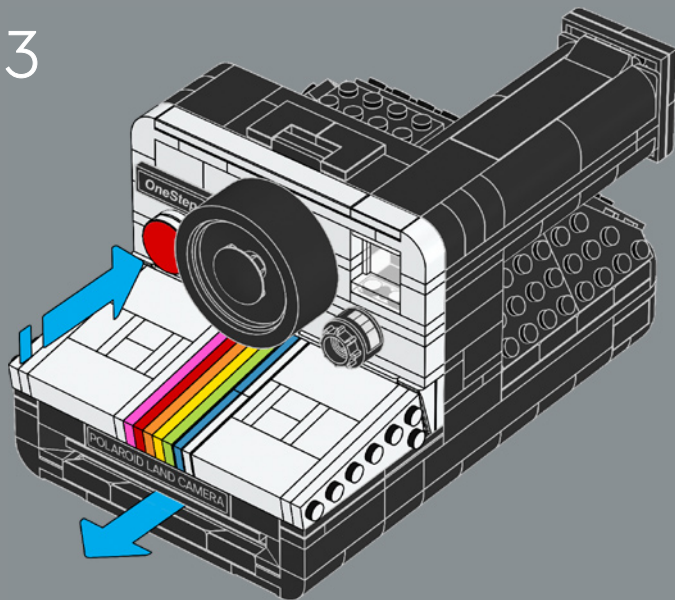



IDEAS

GATHER SUPPORT
OBTENEZ DE L'APPUI
OBTÉN APOYOS

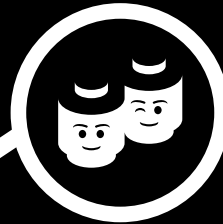

SHARE YOUR IDEA
PARTAGEZ VOTRE IDÉE
COMPARTE TU IDEA

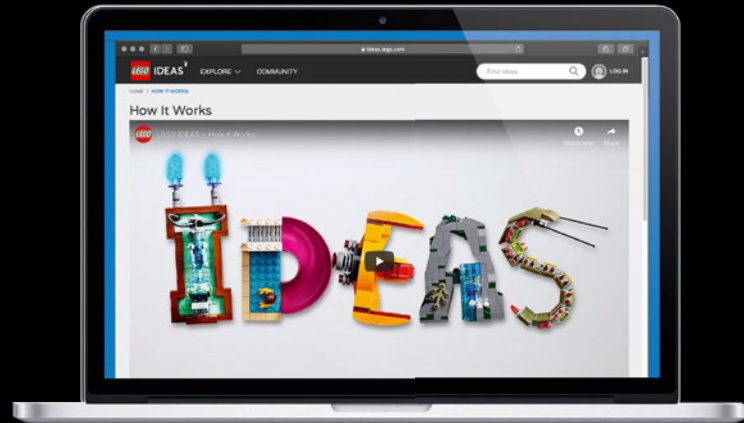
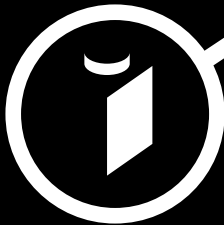

LEGO® REVIEW
EXAMEN LEGO®
REVISIÓN DE LEGO®

NEW LEGO® PRODUCT
NOUVEAU PRODUIT LEGO®
NUEVO PRODUCTO LEGO®



ideas.LEGO.com

4x
300501

4x
302401

2x
6170567

2x
4544140

2x
6392747

2x
6210272

2x
6392746

1x
6464145

1x
614301

6x
300401

1x
6146215

9x
302301

120

2x
306901

2x
6023804

4x
6153776

2x
6346616

1x
235701

2x
6366391

1x
6289797

2x
362301

2x
6223491

2x
6061047

1x
365901

1x
4560178

1x
300101

2x
6285777

5x
366601

1x
6400128

2x
416201

1x
300801

1x
6464144

5x
447701

3x
611101

3x
383201

3x
4528341



1x
6468167



1x
6468166



1x
6468168

1x
4565452

3x
6271820

2x
6378120

2x
4142865

1x
4179355

3x
6092565

2x
4612575

1x
6078641

1x
6129995

1x
370121

1x
303721

1x
6371582

1x
366621

1x
4181138

2x
346021

1x
611121

1x
4624985

1x
6208753

4x
235724

3x
374724

1x
243124

1x
663624

1x
366624

2x
303424

10x
302426

2x
407026

2x
654126

2x
6436425

2x
300526

2x
307026

2x
4504382

1x
4106347

2x
6335317

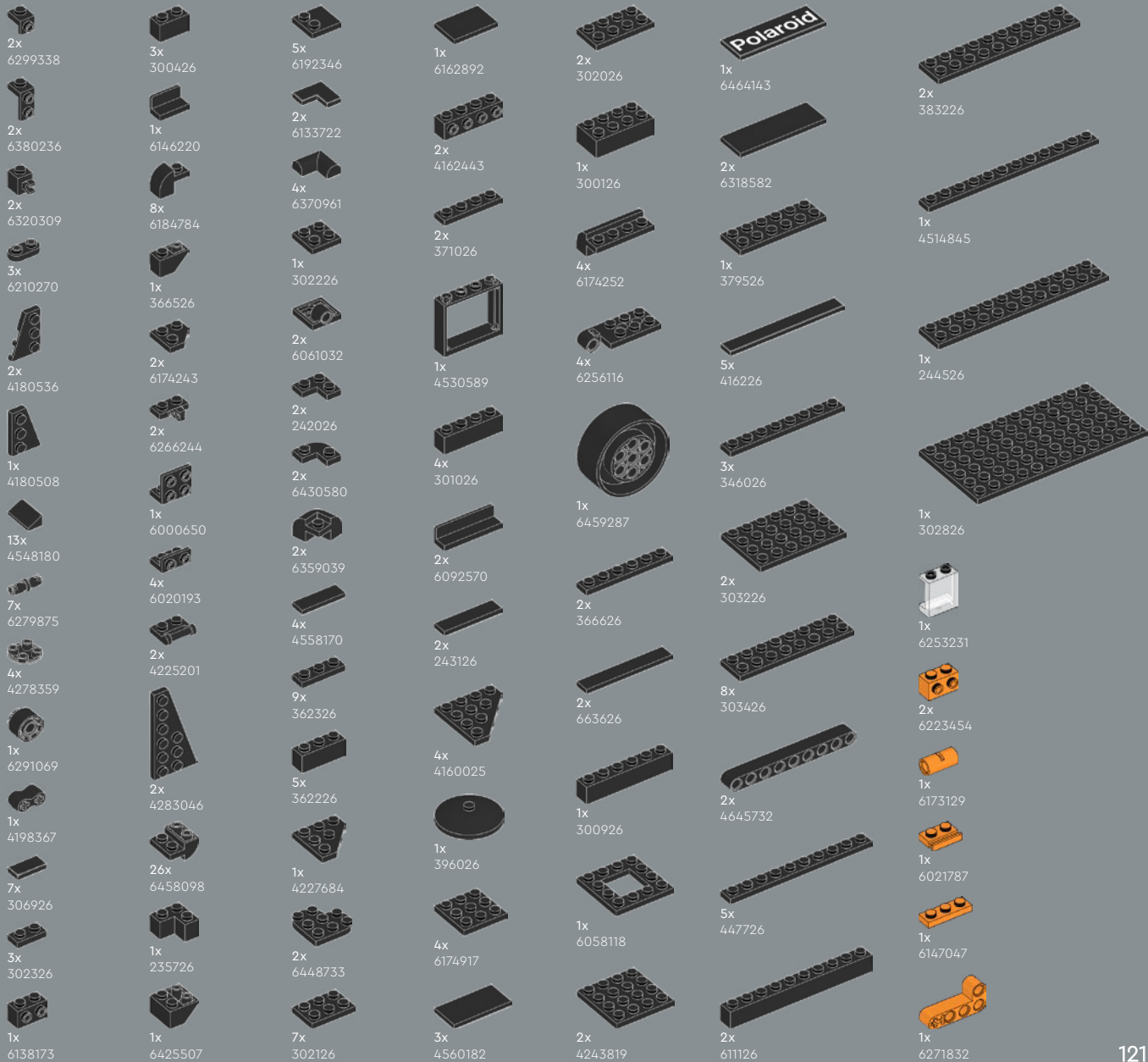

1x
4160593

1x
4118827

1x
4650690

1x
4173332

1x
6240515

4x
4212454

1x
6138661



1x
4166093

2x
6327442

1x
4164021

1x
6454585

1x
6167465

3x
4529160

1x
6381913

1x
4211406

4x
4211462

3x
4211525

4x
6448793

2x
4211535

2x
6335378

3x
4211807

1x
6462467

1x
4211414

2x
6266209

1x
4211398

2x
6446028

2x
4211429

5x
4211445

4x
4211613

2x
6015347

2x
4560183

4x
6290401

4x
4210633

10x
6344022

1x
4210788

1x
4210782

1x
6350724

5x
6258991

1x
6083620

9x
6057387

1x
6147732

6x
6056263

1x
4649764

1x
6097094

3x
6446031

5x
6004943

1x
6292486

1x
6298471

2x
6459289

1x
6205089

1x
6164336

3x
4640891

1x
6343649

 [LEGO.com/service](https://www.LEGO.com/service)



YOU COULD WIN



YOU COULD WIN

Your feedback will help shape the future development of this product series.

Visit:

DU KÖNNTEST GEWINNEN

Dein Feedback trägt zur Weiterentwicklung dieser Produktreihe bei.

Geh auf:

VOUS POURRIEZ GAGNER

Vos commentaires nous aideront à concevoir les futurs produits de cette gamme.

Visitez :

POTRESTI VINCERE TU

La tua opinione ci aiuterà a migliorare la creazione futura di questa linea di prodotti.

Visita:

PUEDES GANAR

Tu opinión contribuirá al futuro de esta serie de productos.

Visita:

轻松获奖

您的反馈将有助于我们在今后改进本产品系列。

请访问：

LEGO.com/productfeedback

You also have the chance to win a LEGO® set.

Terms and conditions apply.*

Außerdem hast du die Chance, ein LEGO® Set zu gewinnen.

Es gelten die Teilnahmebedingungen.*

Vous pourriez également gagner un ensemble LEGO®.

Des conditions s'appliquent.*

Hai anche la possibilità di vincere un set LEGO®.

Termini e condizioni sono applicabili.*

También tienes la oportunidad de ganar un set LEGO®.

Aplican términos y condiciones.*

您还有机会赢取乐高®套装。

条款和条件适用。*

*LEGO.com/productfeedback-terms

The image features a vertical rainbow spectrum background with six distinct color bands: red, orange, yellow, green, and blue. The word "polaroid" is centered in the upper portion of the spectrum in a white, lowercase, sans-serif font.

polaroid

LEGO and the LEGO logo are trademarks of the/
sont des marques de commerce du/
son marcas registradas de LEGO Group.
©2024 The LEGO Group. 6494183

POLAROID, SX-70, ONESTEP and the Polaroid Color
Spectrum are protected trademarks of Polaroid.