



**MARVEL**

**76245**





### **Get excited about our new packaging!**

We're switching from plastic to paper-based packaging. That's why you might find a mix of paper and plastic in our boxes!

### **Nos nouveaux emballages vous emballeront !**

Nous passons des emballages en plastique aux emballages à base de papier. C'est pourquoi vous pourriez trouver un mélange de papier et de plastique dans nos boîtes !

### **¡Te presentamos nuestros nuevos empaques!**

Estamos sustituyendo las bolsas de plástico por bolsas con base de papel. ¡Por eso, puedes encontrar una mezcla de papel y de plástico en nuestras cajas!

**[LEGO.com/sustainable-packaging](https://www.lego.com/sustainable-packaging)**



# BUILDER



Apple and the Apple logo are trademarks of Apple Inc., registered in the U.S. and other countries and regions. App Store is a service mark of Apple Inc. Google Play and the Google Play logo are trademarks of Google LLC. Tencent and the Tencent logo are trademarks of Tencent Inc.

[LEGO.com/devicecheck](https://www.lego.com/devicecheck)

EN Ask parents' permission before going online | DE Eltern um Erlaubnis bitten, bevor du online gehst | FR Demande l'autorisation d'un parent avant d'aller en ligne | IT Chiedi il permesso ai tuoi genitori prima di andare online | ES Pídeles permiso a tus papás antes de conectarte a Internet | PT pede autorização aos pais antes de acederes online | JA オンラインになる前にほご者の方のきよかをもらおう | ZH 上网前应先征得父母的同意 | KO 온라인 접속 전에 보호자 동의가 필요합니다 | RU Спроси разрешения у родителей, прежде чем заходить в интернет | PL Poproś rodziców o zgodę, zanim wejdiesz do Internetu | CS Než půjdeš na internet, požádej rodiče o svolení | SK Skôr než pôjdeš na internet, vypýtaj si povolenie od rodičov | HU Kérj szülői engedélyt, mielőtt online csatlakoznál! | RO Cere permisiunea părinților înainte de a te conecta online | BG Поискайте разрешение от родител, преди да влезете онлайн | LV Pirms došanās tiešsaistē palūdz atļauju vecākiem | ET Enne Interneti kasutamist küsi vanematelt luba | LT Prieš prisijungdami prie interneto, atsiklauskite tėvų

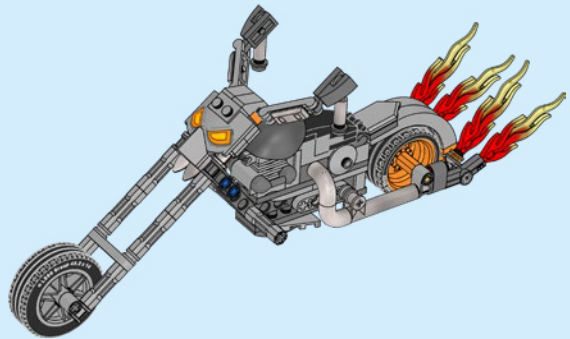
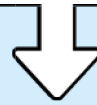
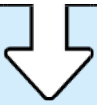

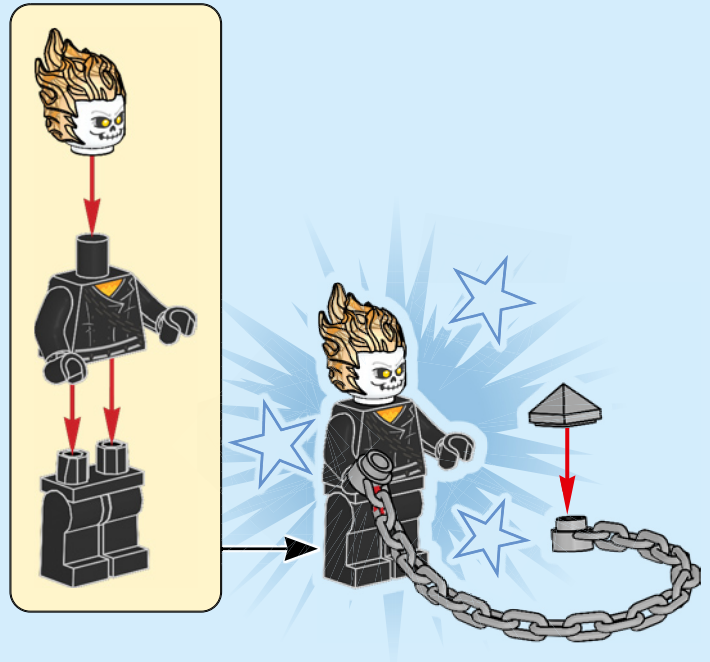

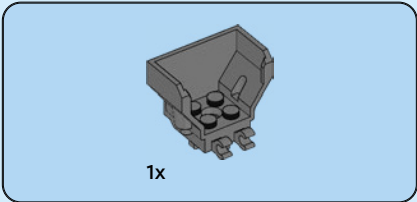
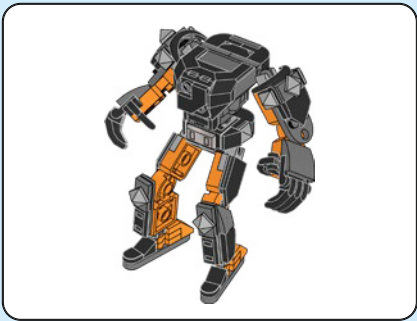

1

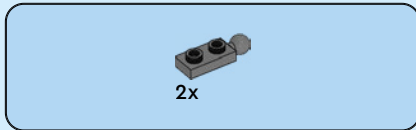
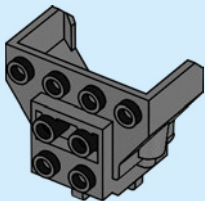

2

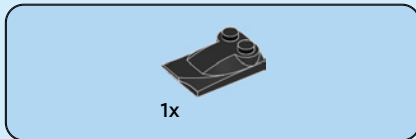
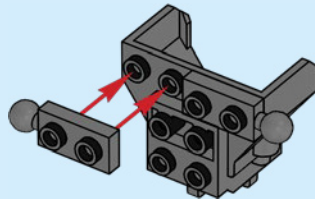

3

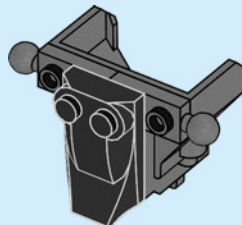



2x

4

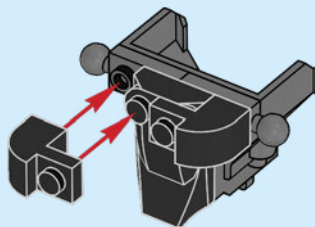

1x

5

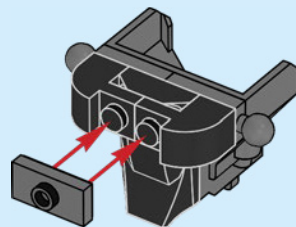

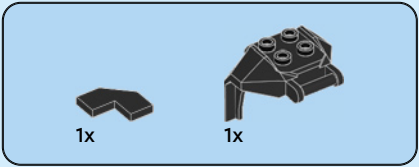

6

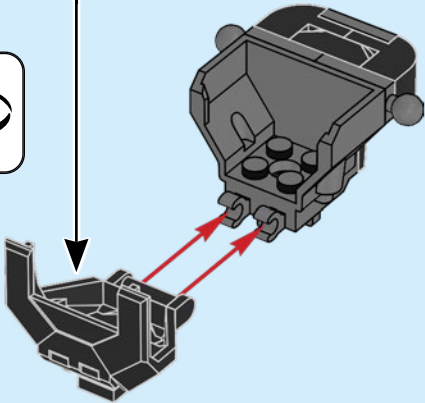
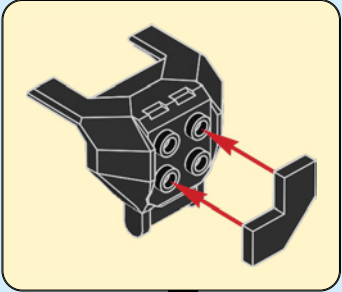

7

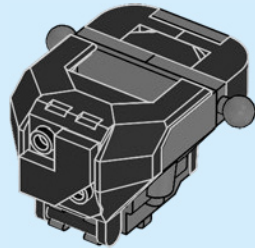



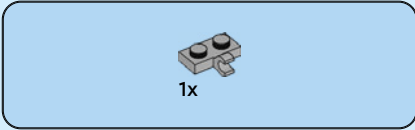
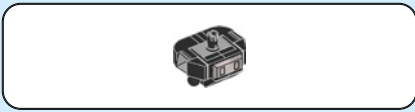

8

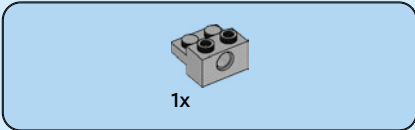
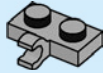

9

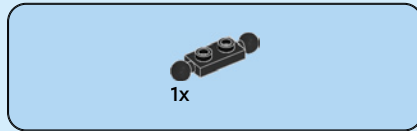
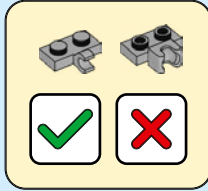
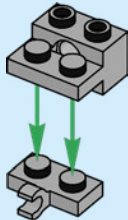

10

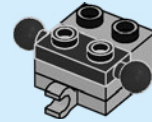

11

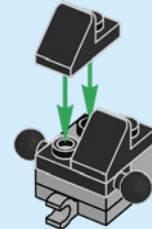



2x

# 12

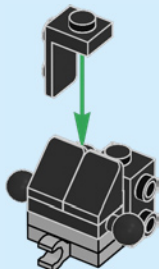

2x



1x

# 13

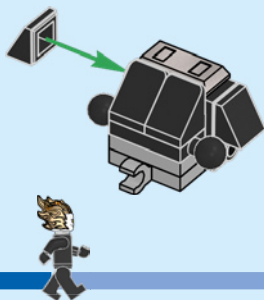

1x



1x



1x

# 14

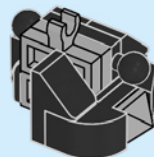
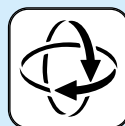
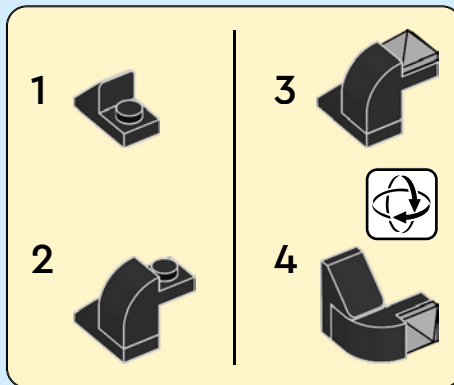



15

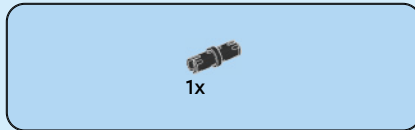
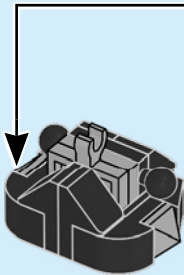
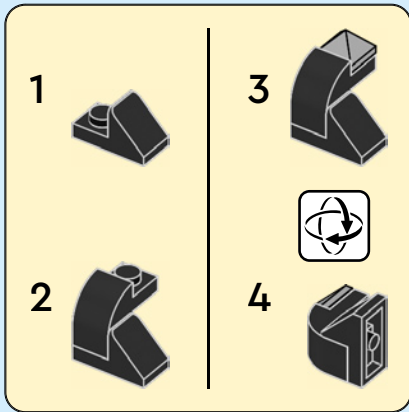

16

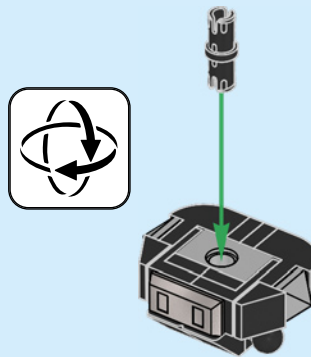

17

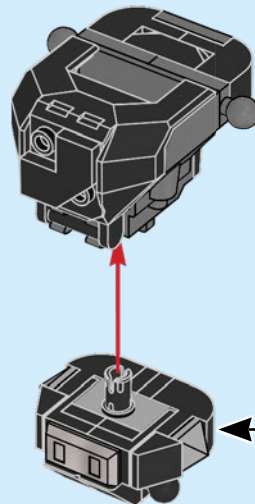



1x

18

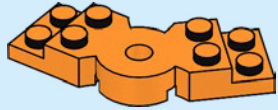

2x

19

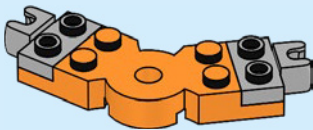

1x

20

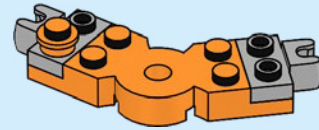

1x



1x

21

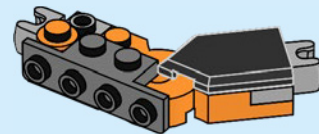

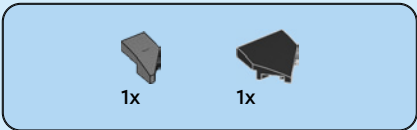

22

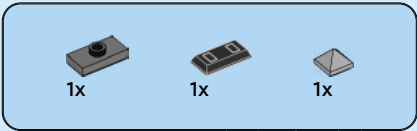
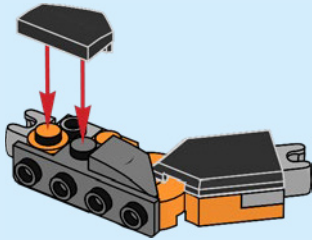

23

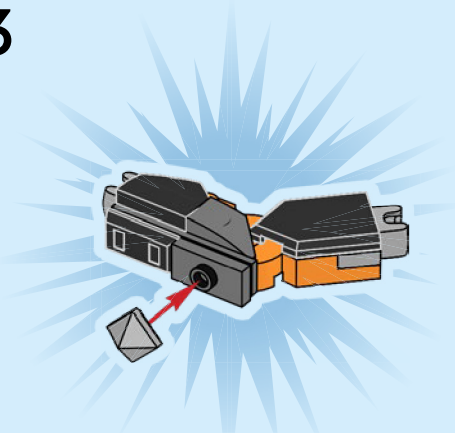

24

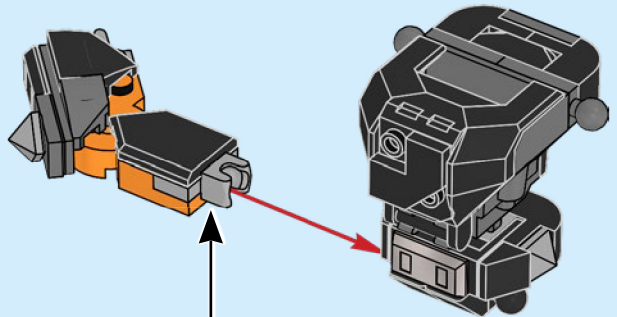



1x

25

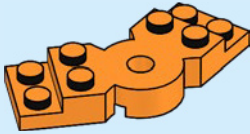

2x

26

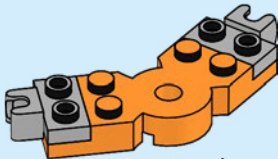

1x

27

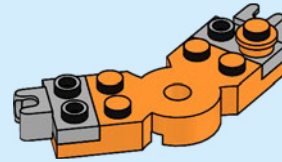

1x



1x

28

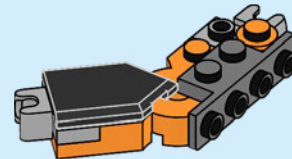

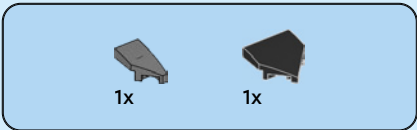

29

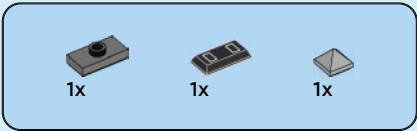
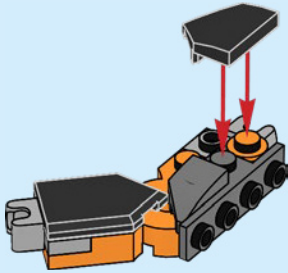

30

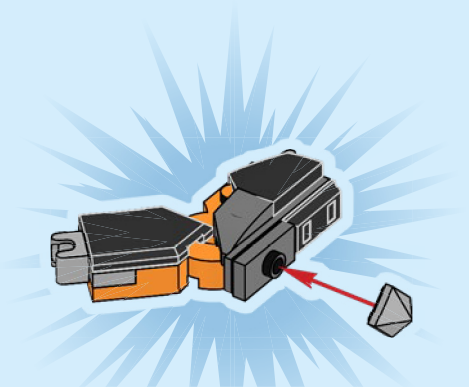

31

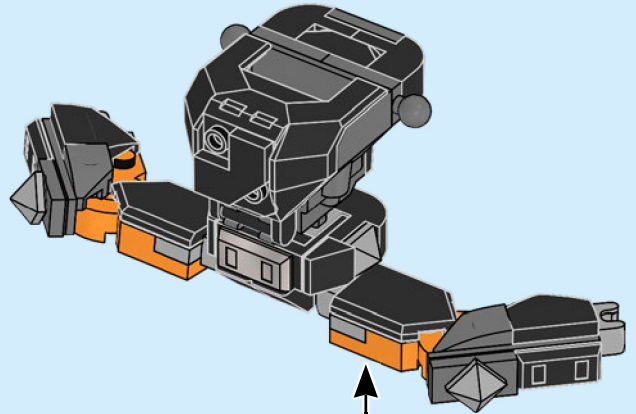



2x



1x



1x

32

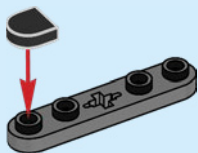

1x



2x

33

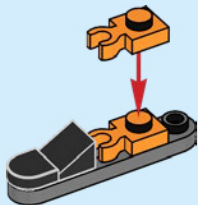

1x

34

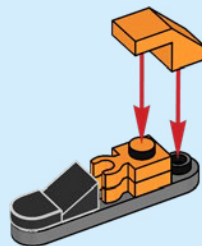

1x

35

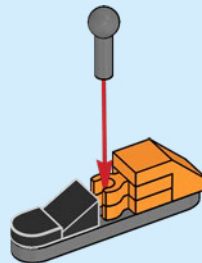

2x



36

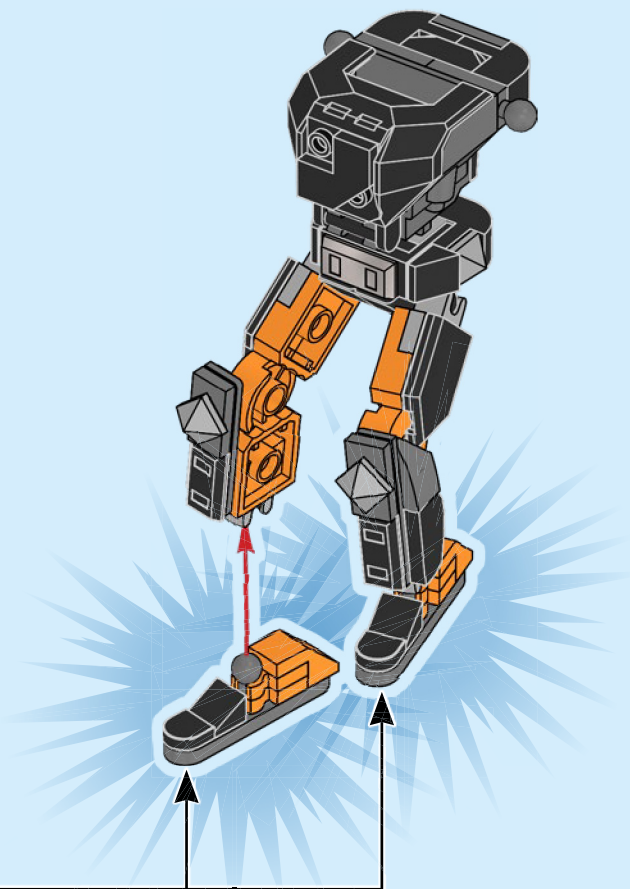



1x

37

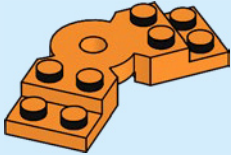

1x

38

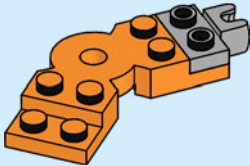

1x



3x

39

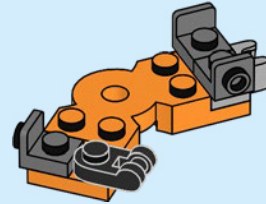

1x

40

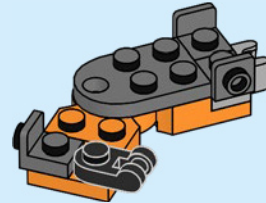



41

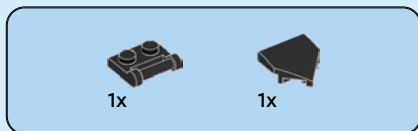
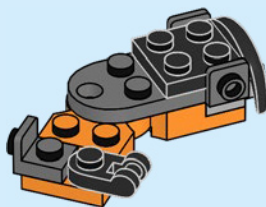

42

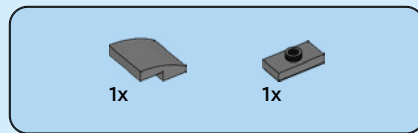
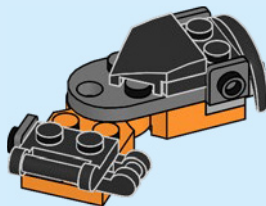

43

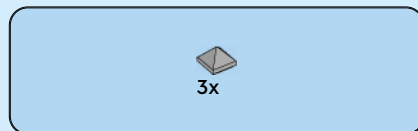
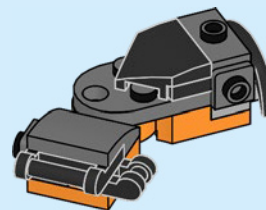

44

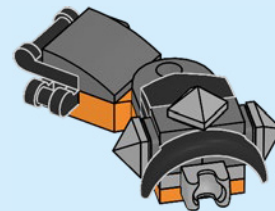



4x

45

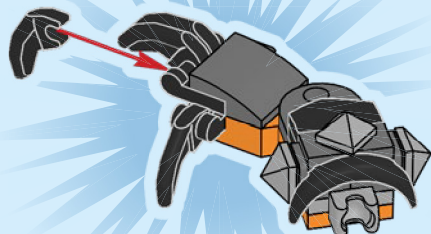

46

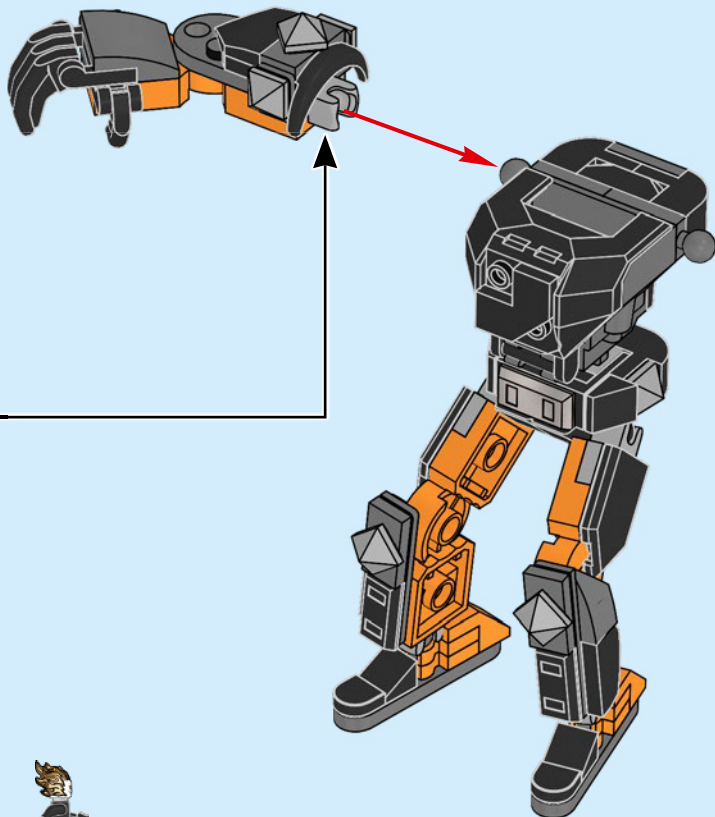

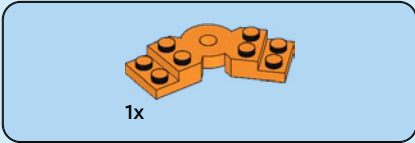
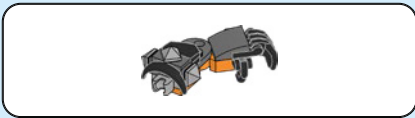

47

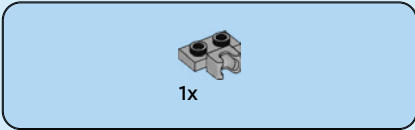

48

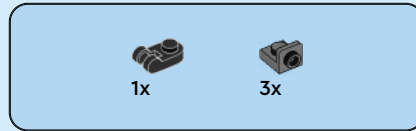
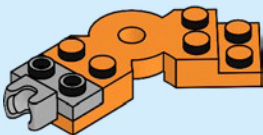

49

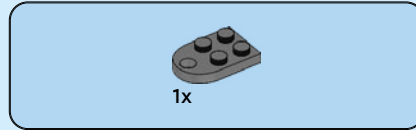
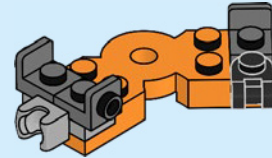

50

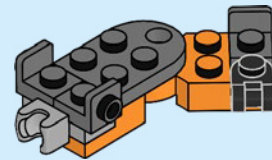



1x

51

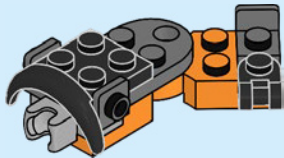

1x



1x

52

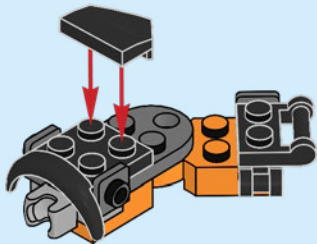

1x



1x

53

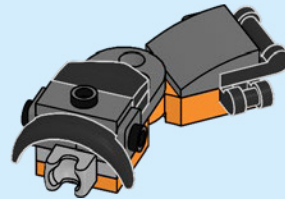

3x

54

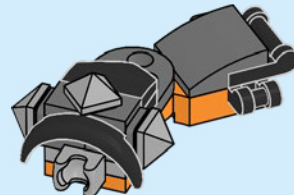



4x

55

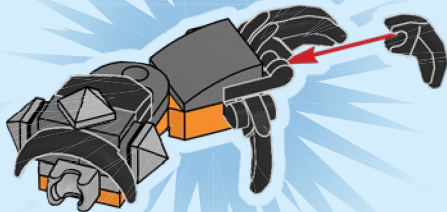

56

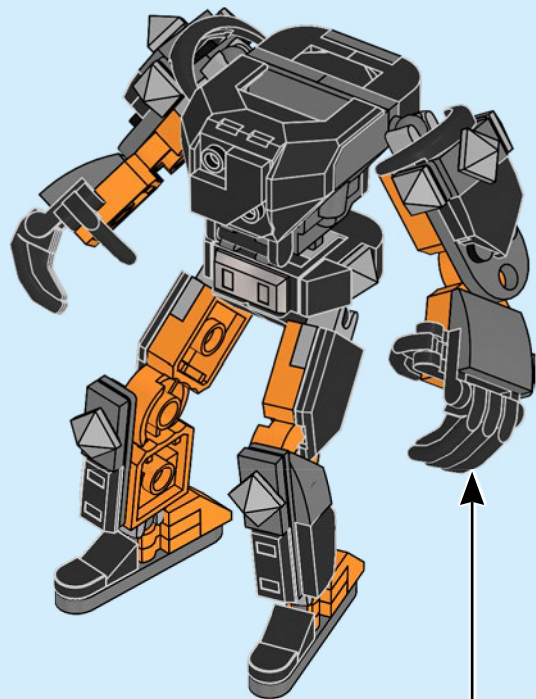

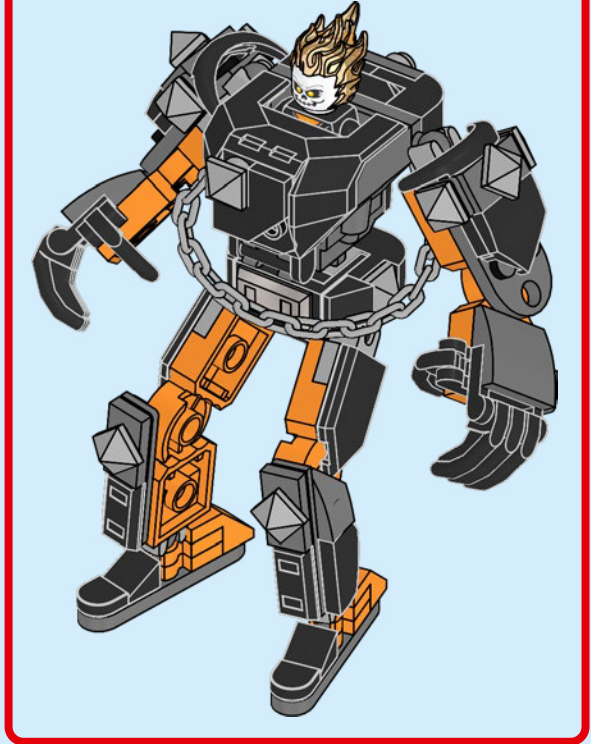
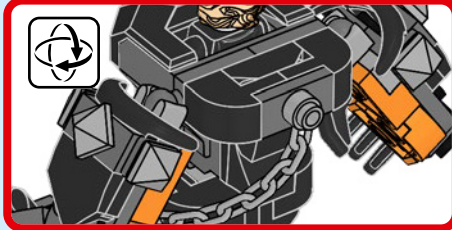
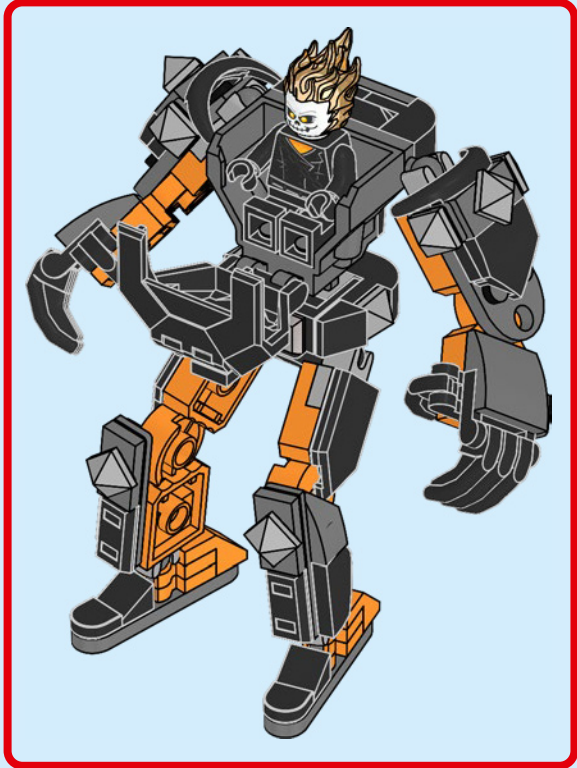



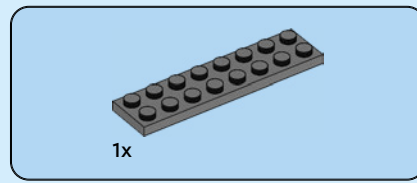

1

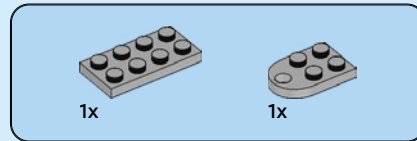
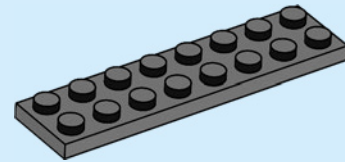

2

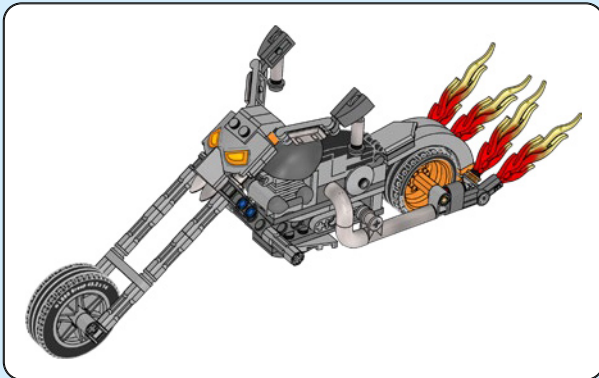
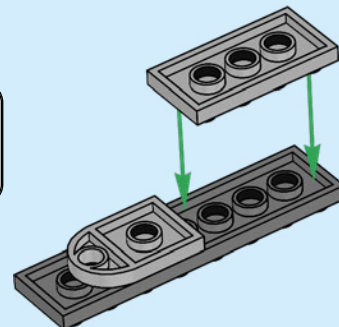

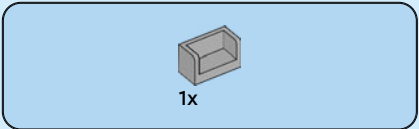

3

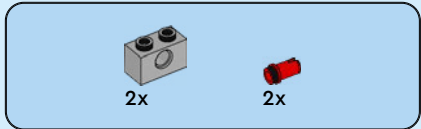
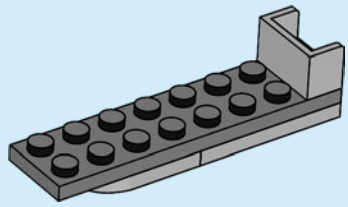

4

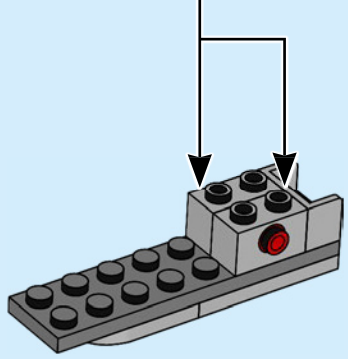
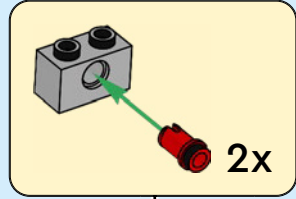

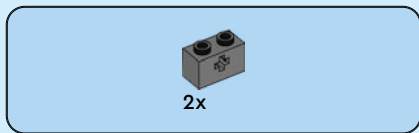

5

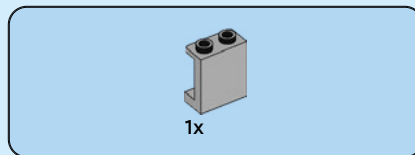
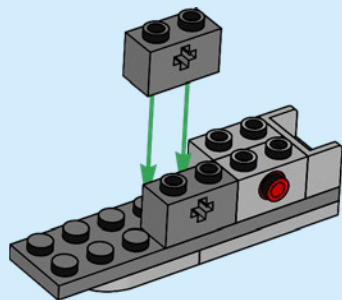

6

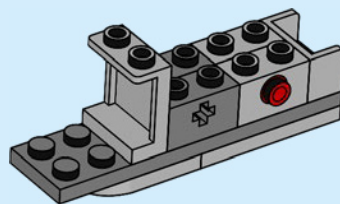

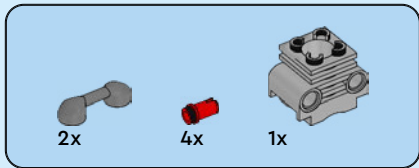

7

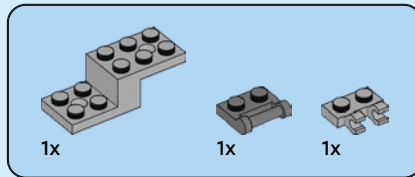
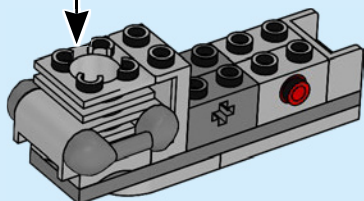
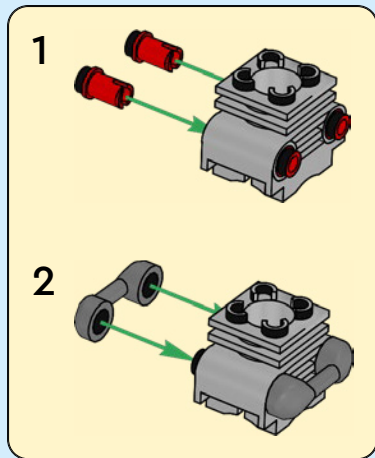

8

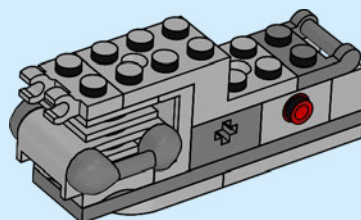

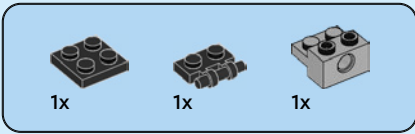

9

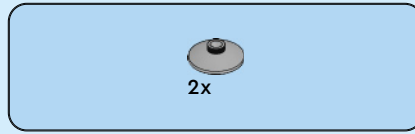
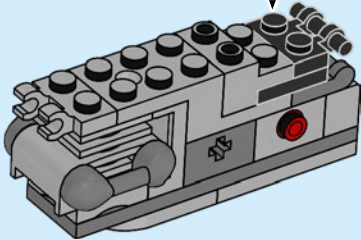
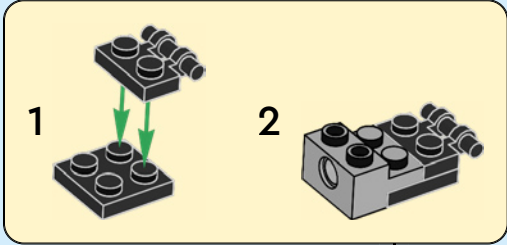

10

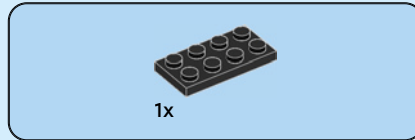
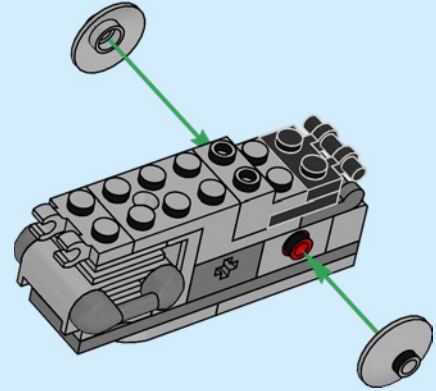

11

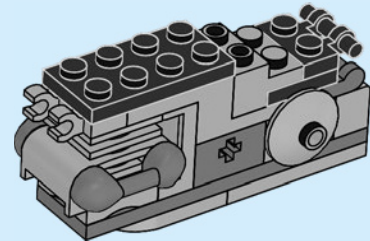

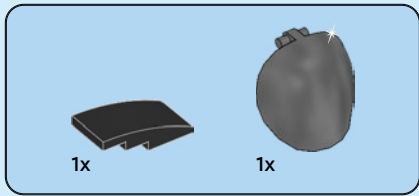

12

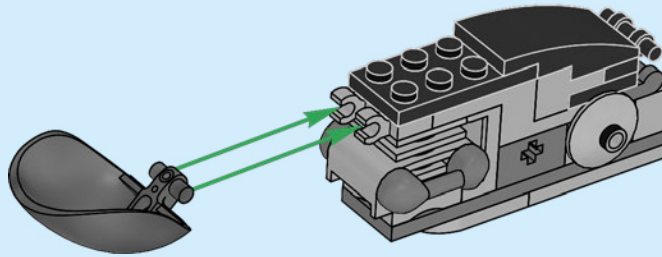

13

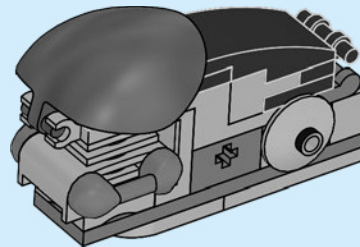

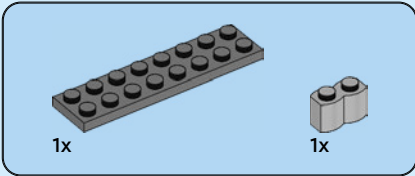
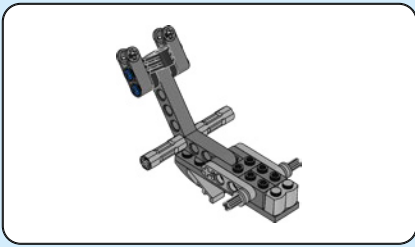

14

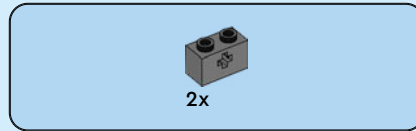
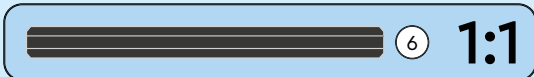
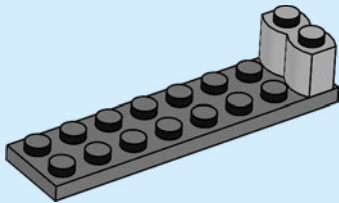

15

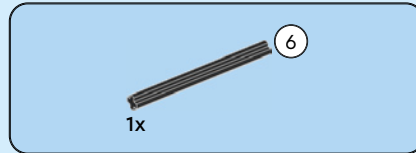
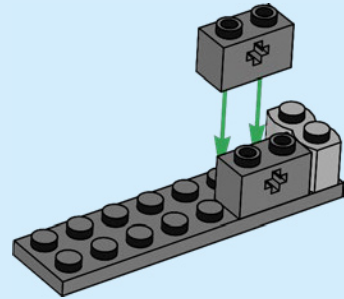

16

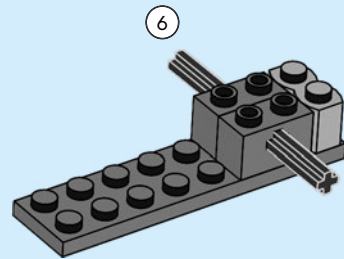

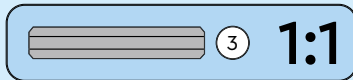
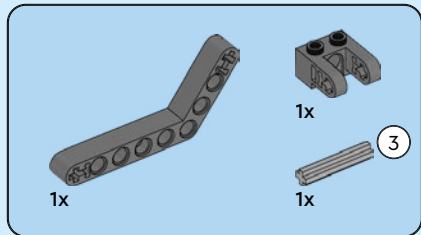

17

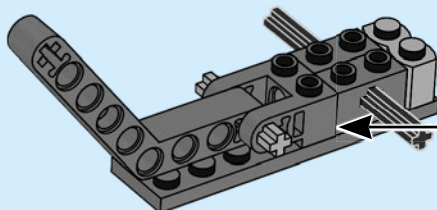
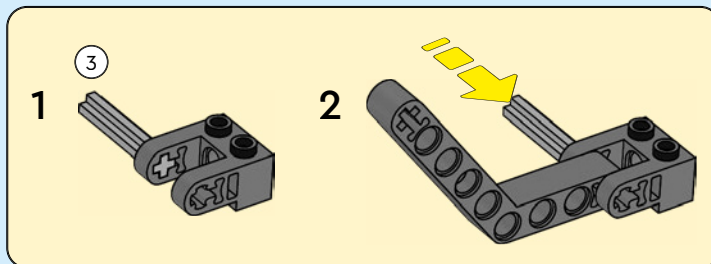



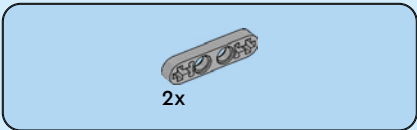

18

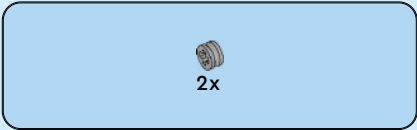
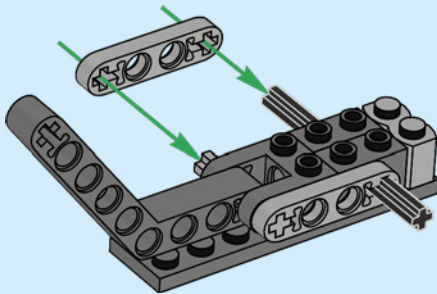

19

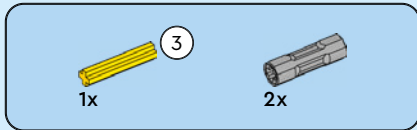
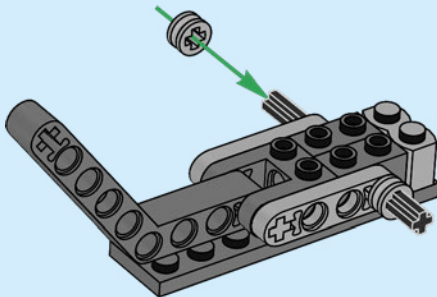

20

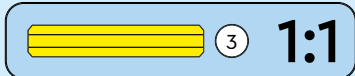
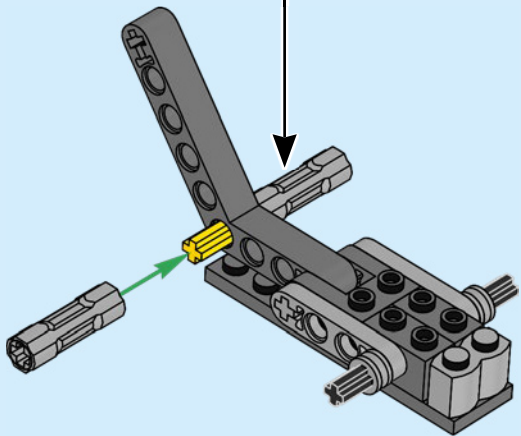
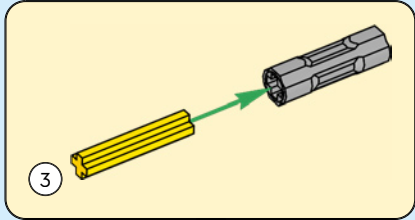

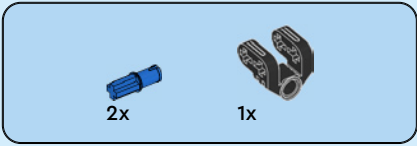

21

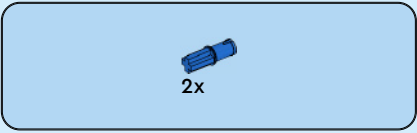
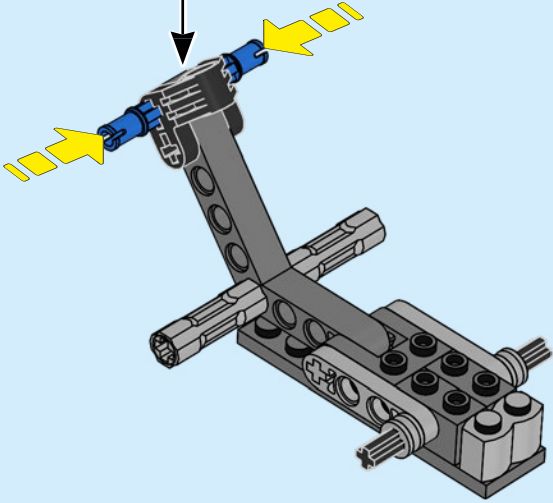
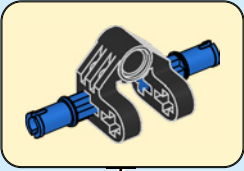

22

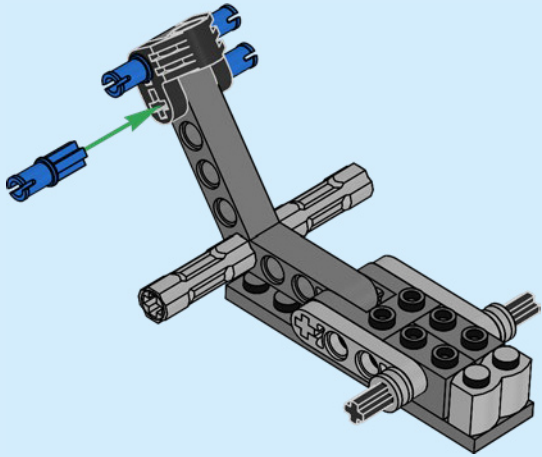



2x

23

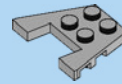
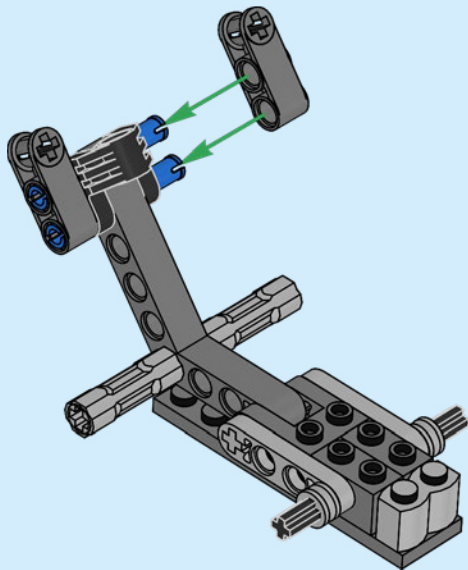

1x

24

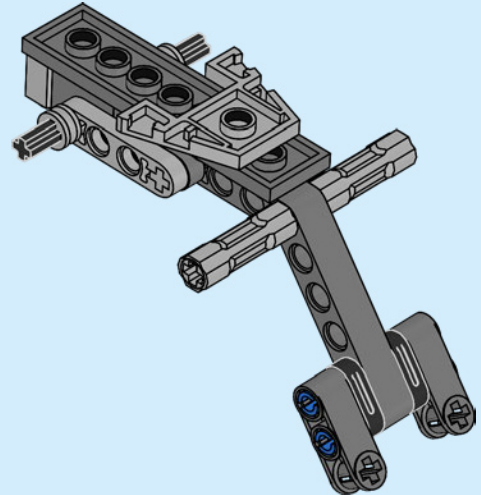
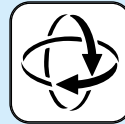



2x

25

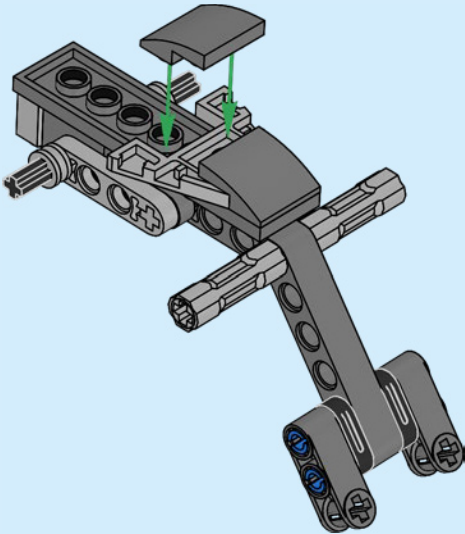

26

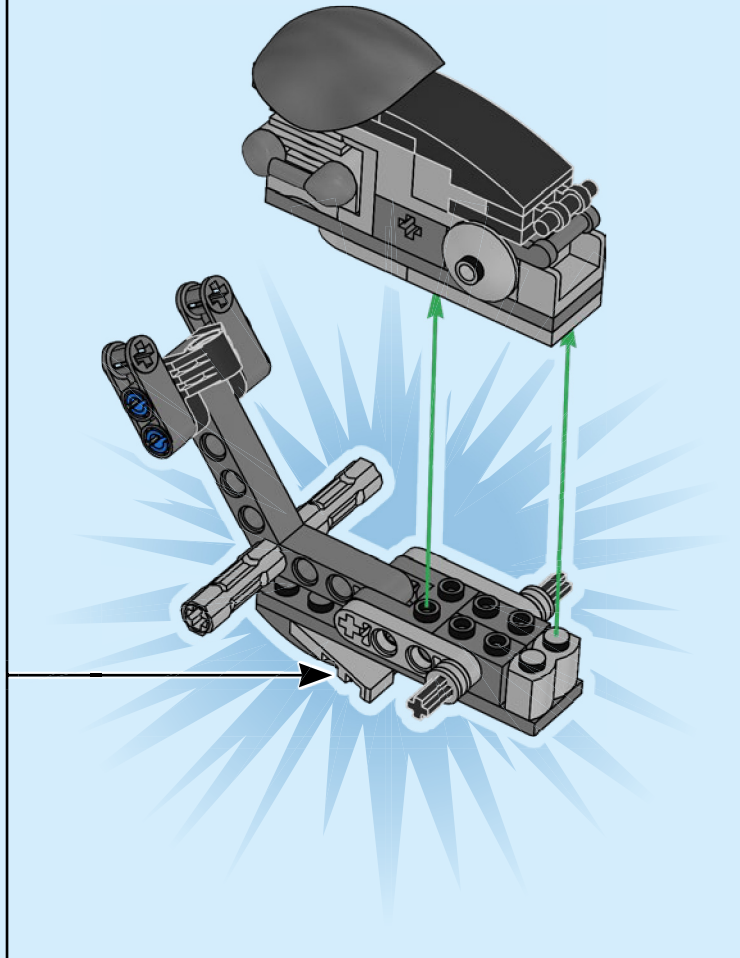

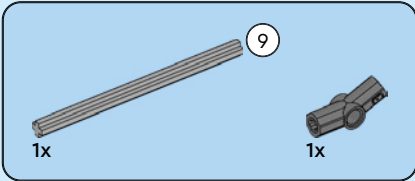
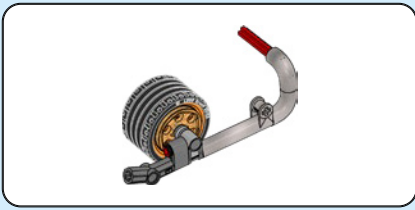

27

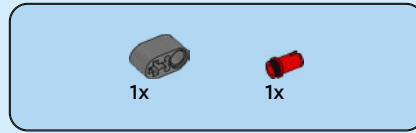
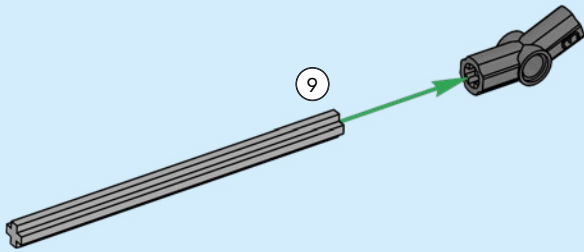

28

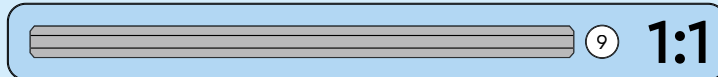
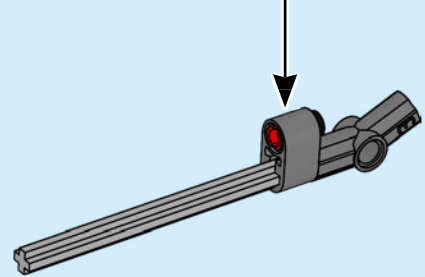
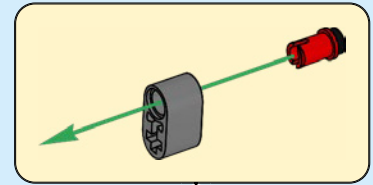

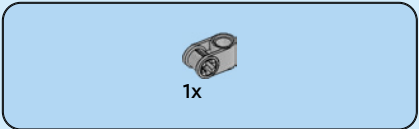

29

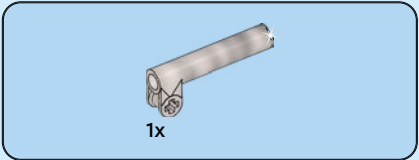
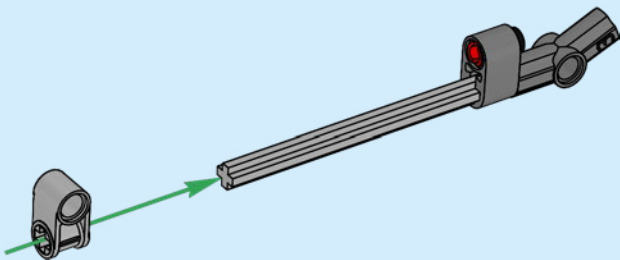

30

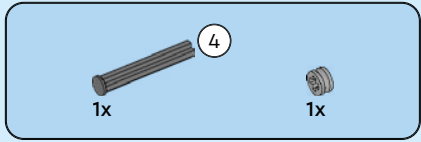
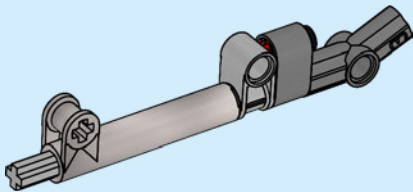

31

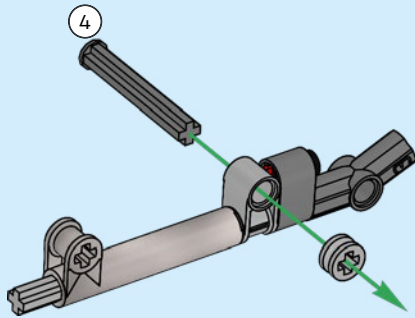

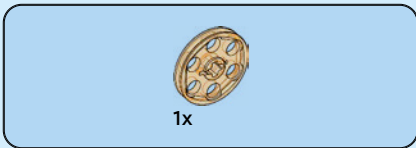

32

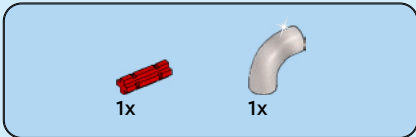
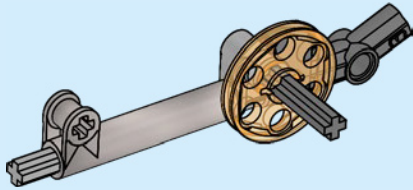

33

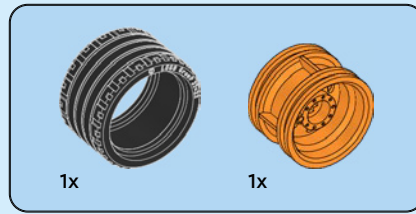
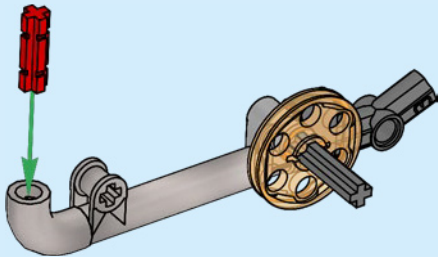

34

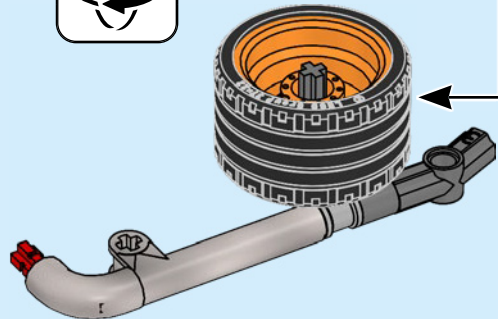
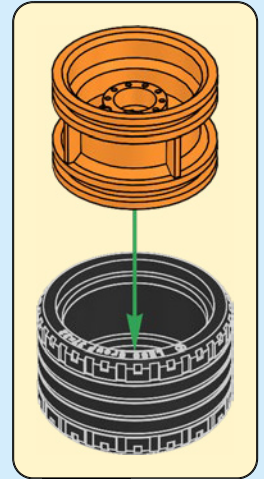

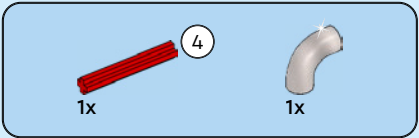

35

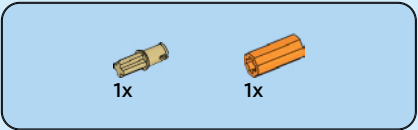
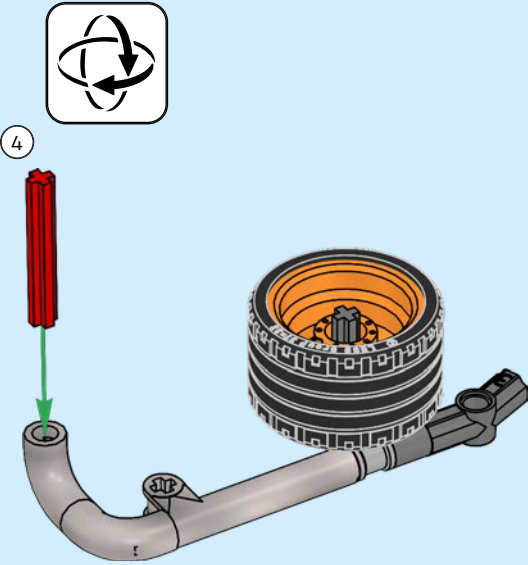

36

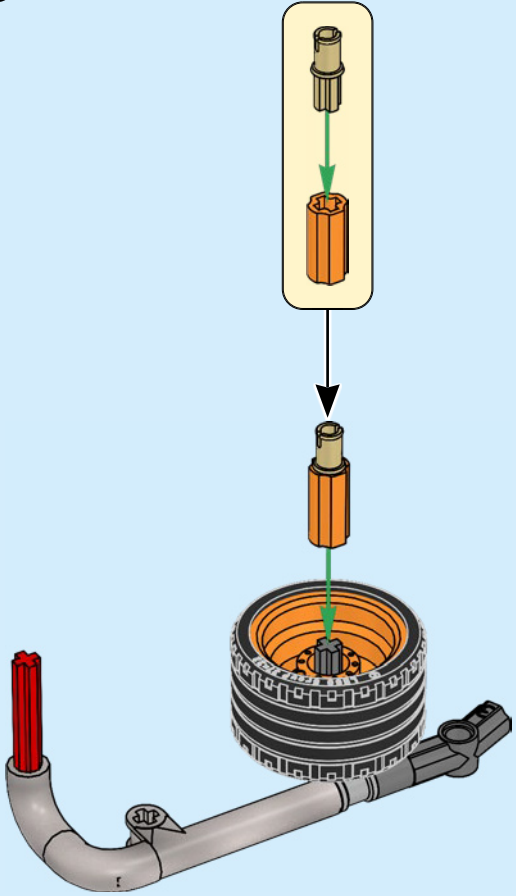



37

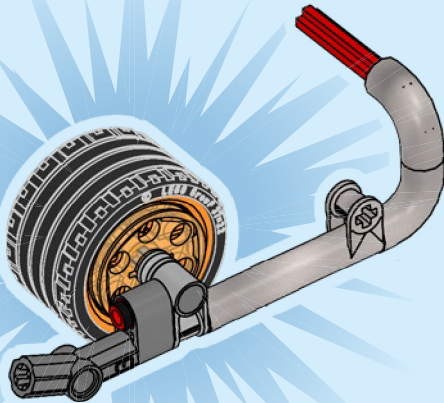

38

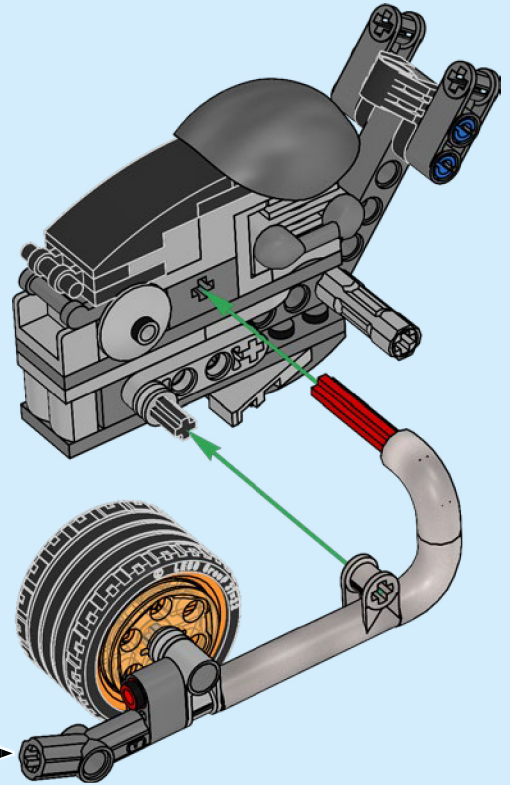

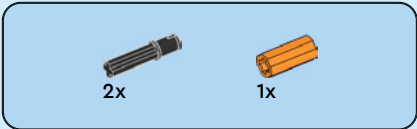

39

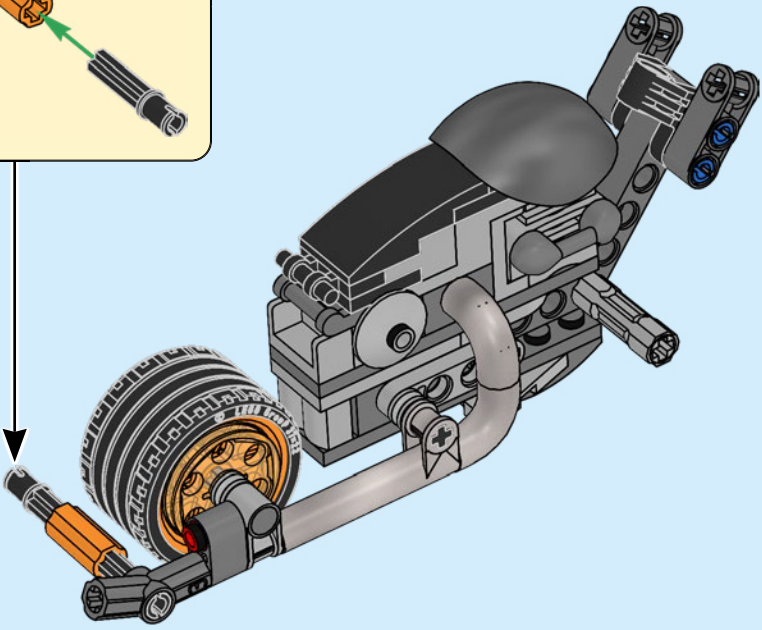
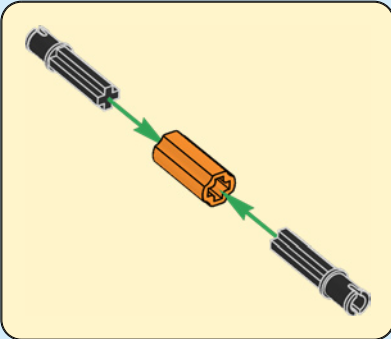

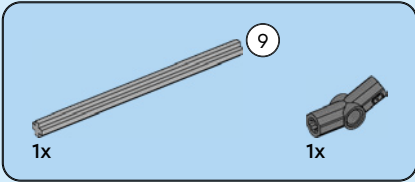
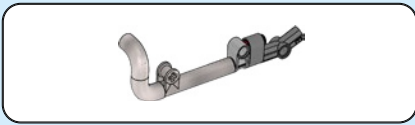

40

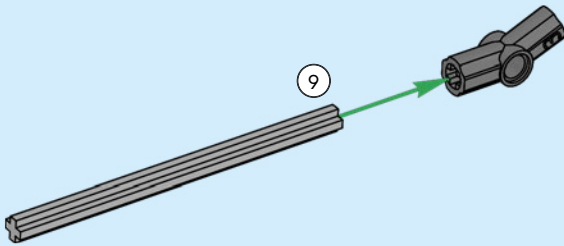

41

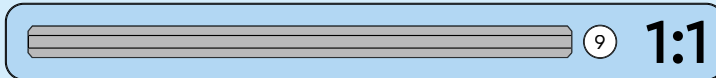
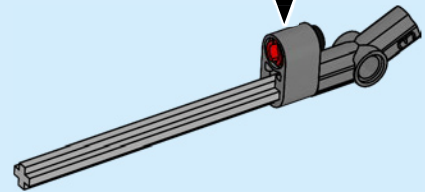
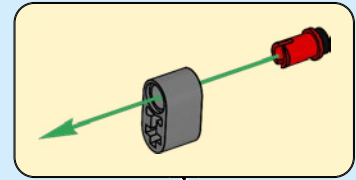



42

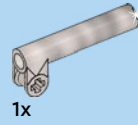
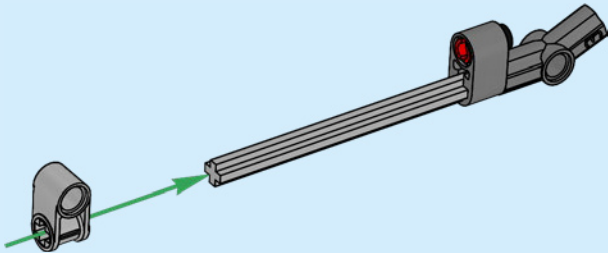

43

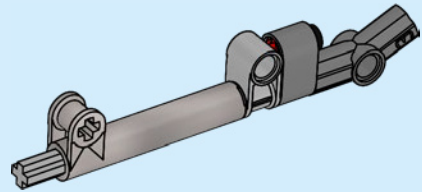

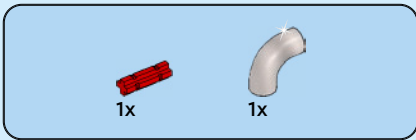

44

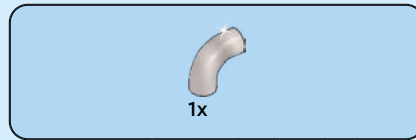
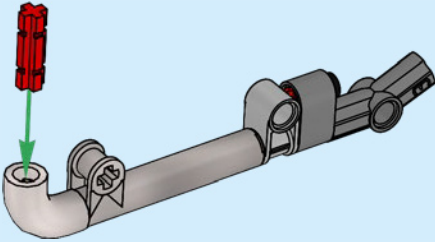

45

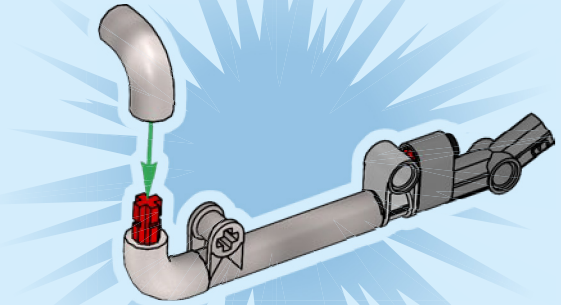

46

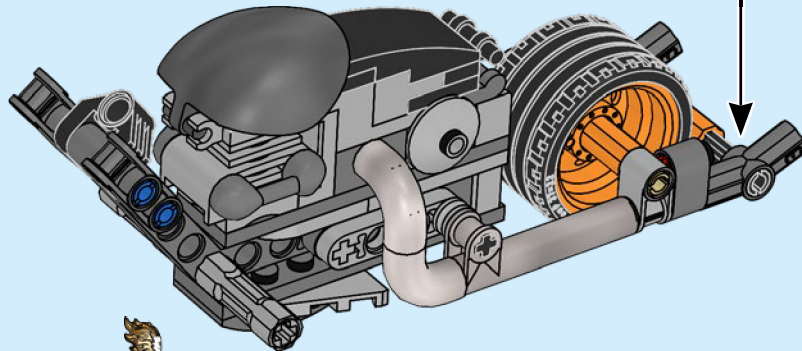

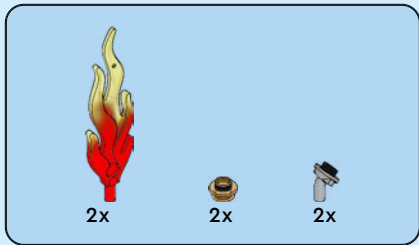

47

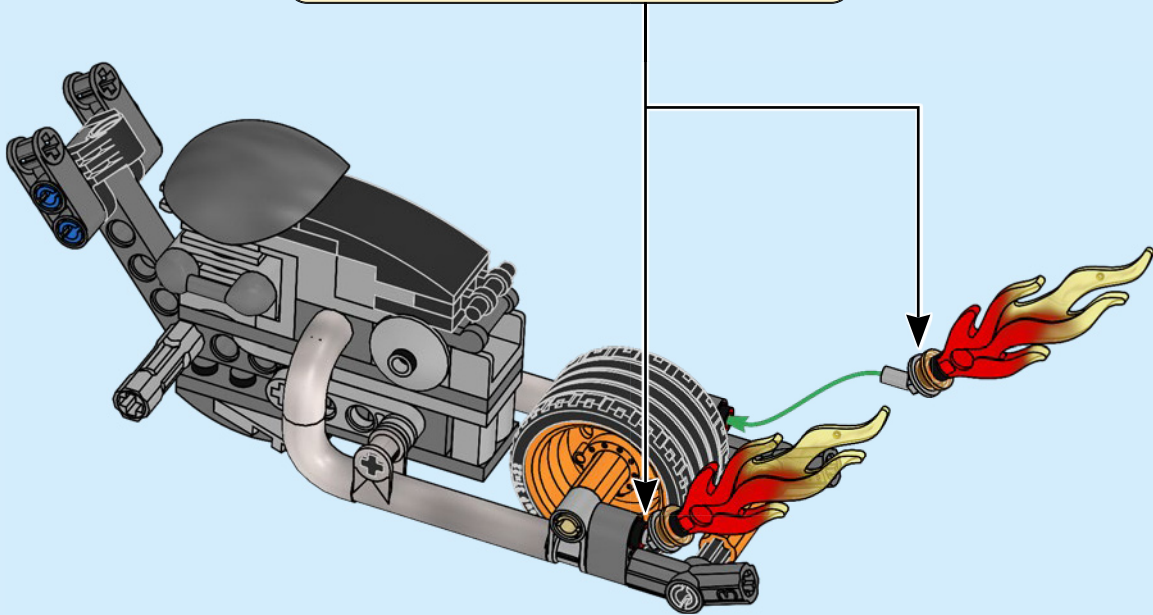

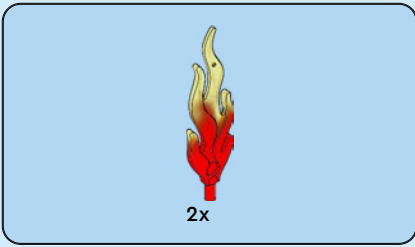

48

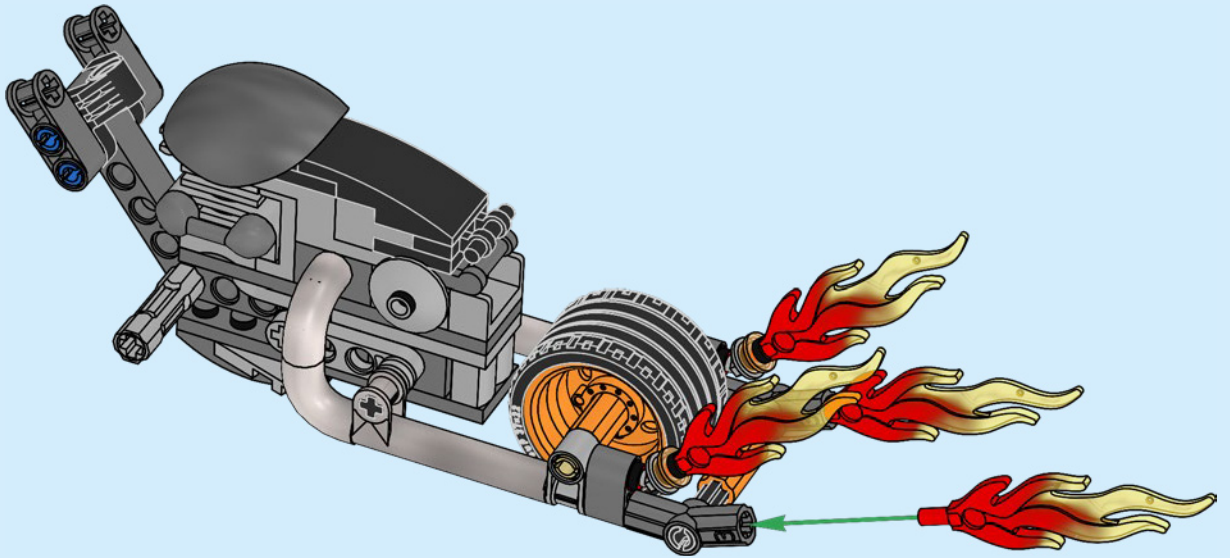

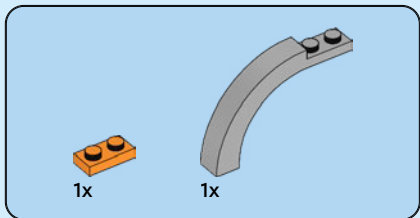
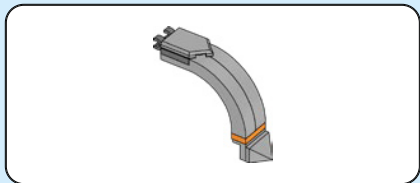

49

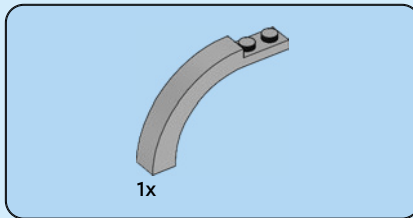
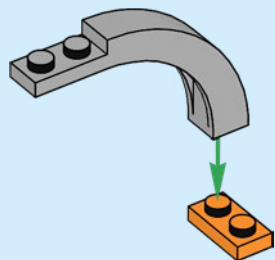

50

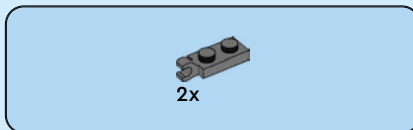
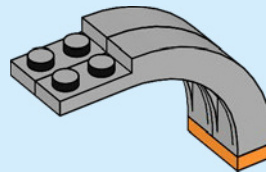

51

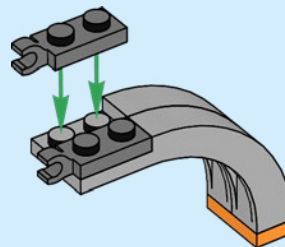



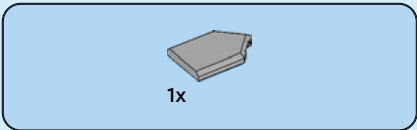

52

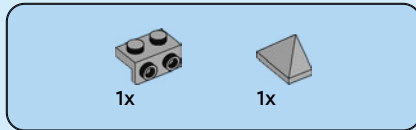
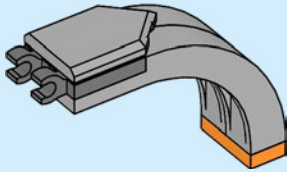

53

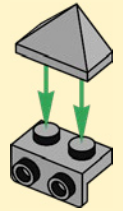
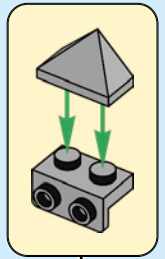
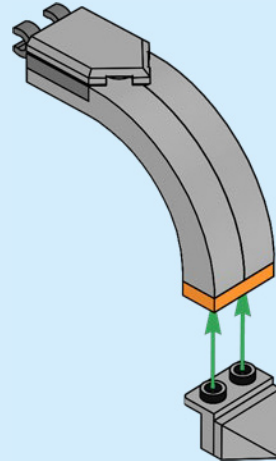
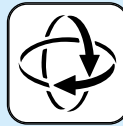

54

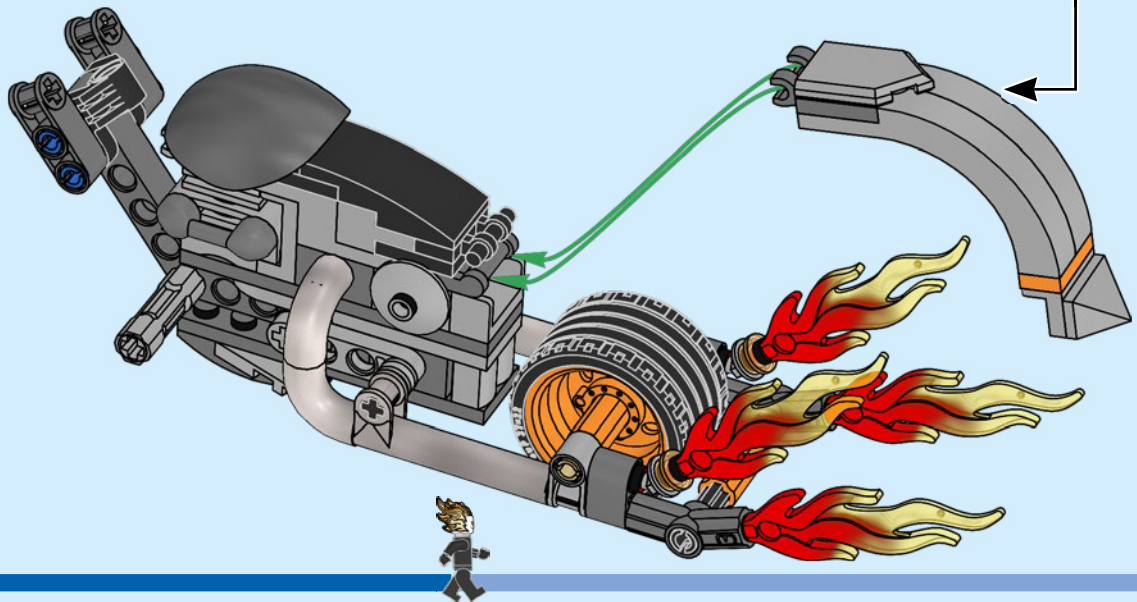



1x



1x

# 55

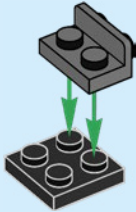

1x

# 56



2x

# 57

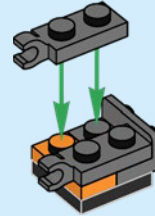

1x



2x

# 58

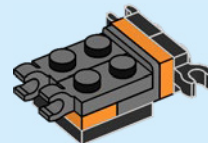
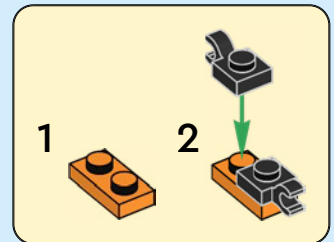



2x



1x

# 59

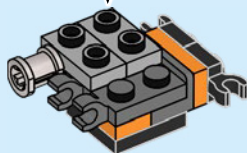
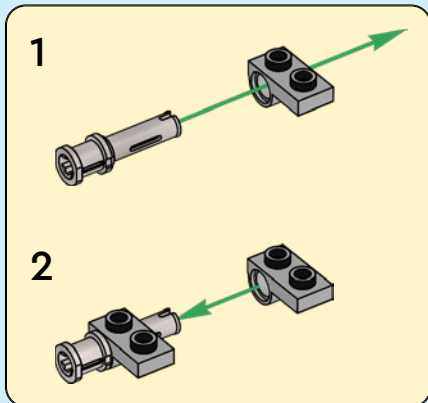

2x



1x

# 60

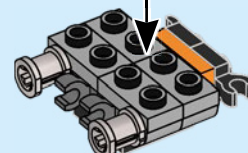
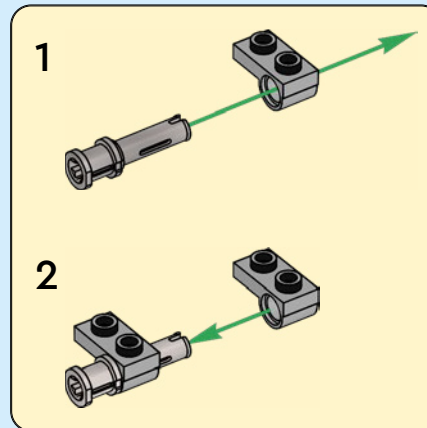



1x

61

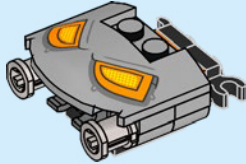

1x

62

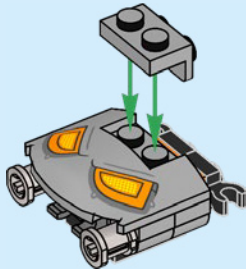

2x

63

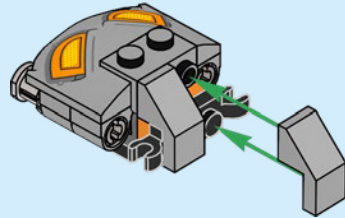

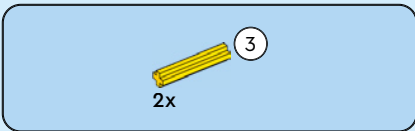

64

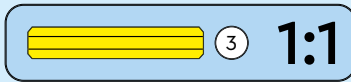
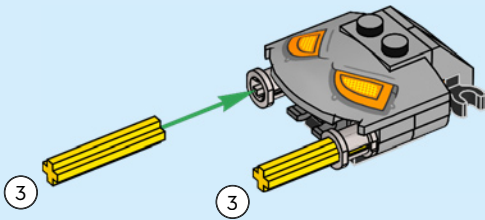

66

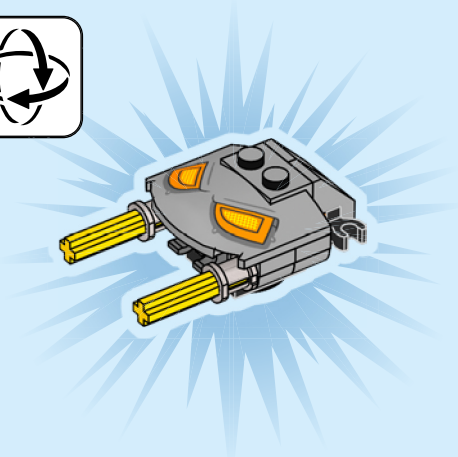
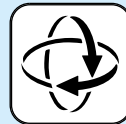

65

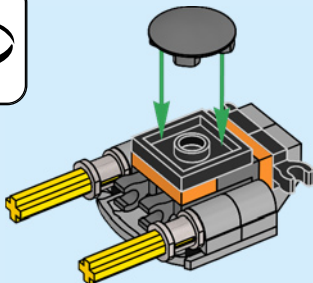

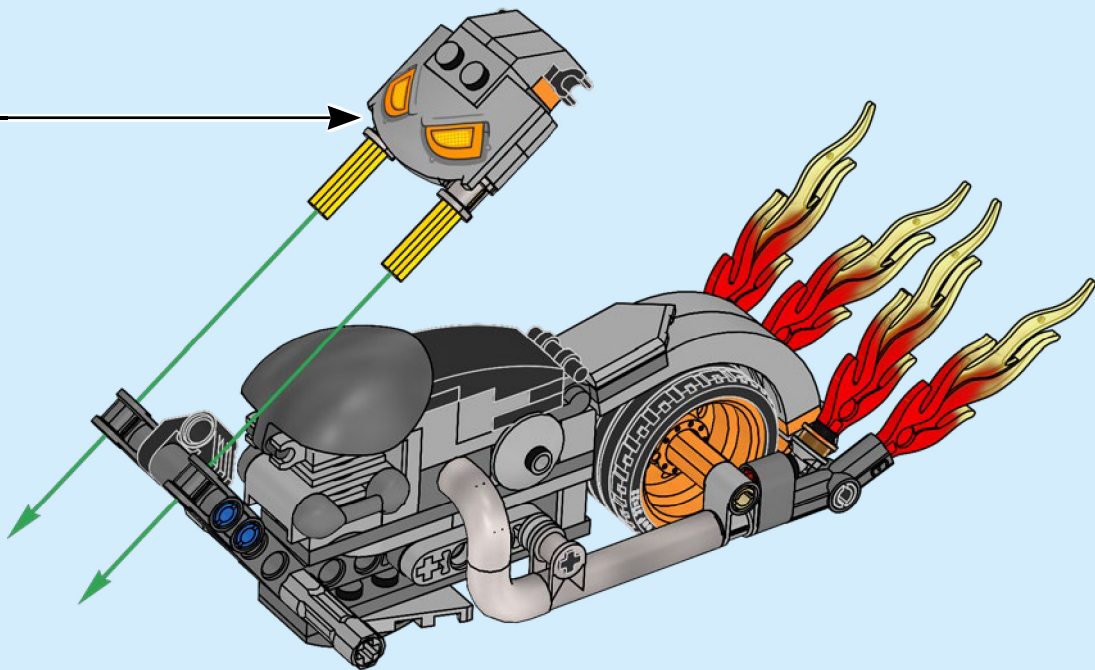

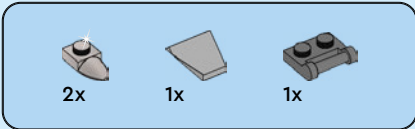

68

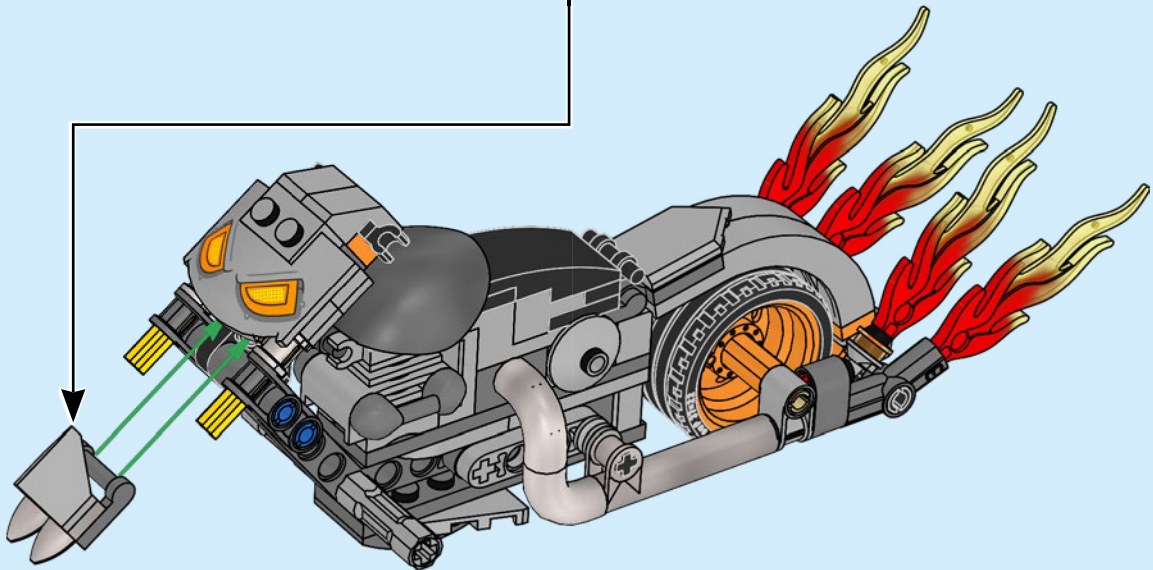
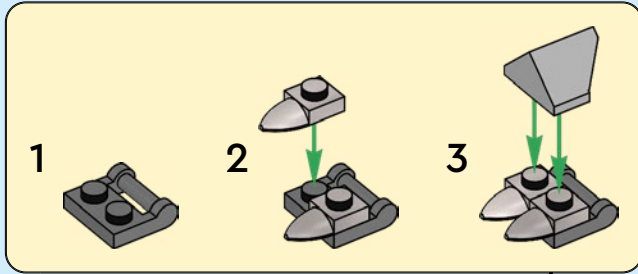

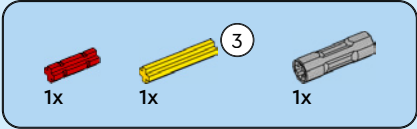
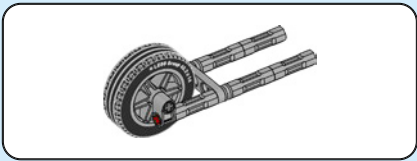

69

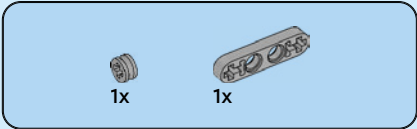
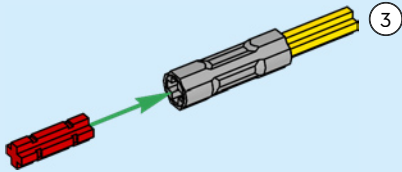

70

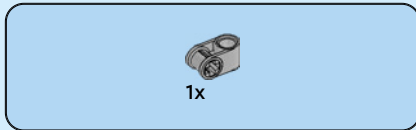
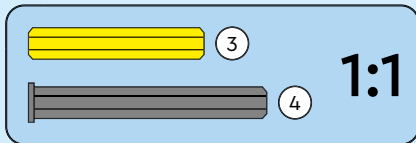
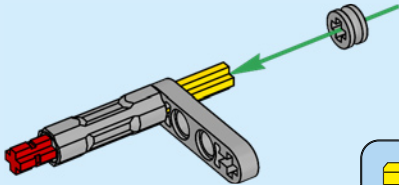

71

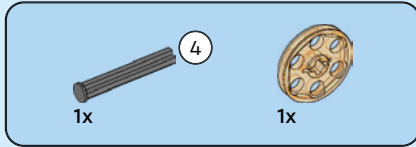
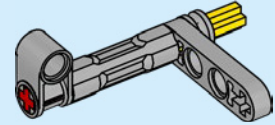

72

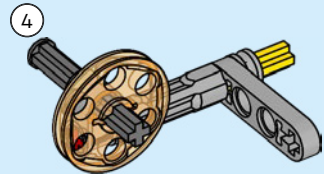



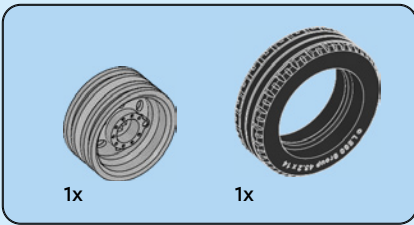

73

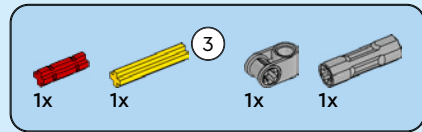
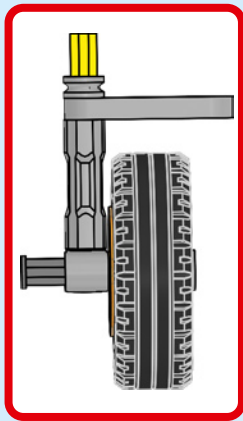
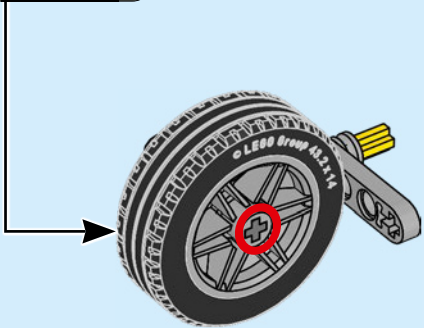
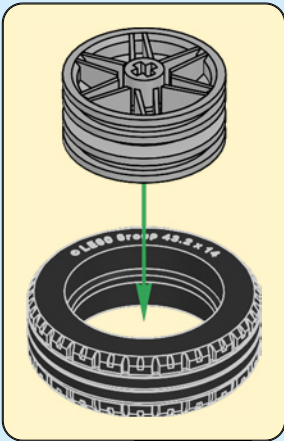

74

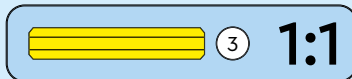
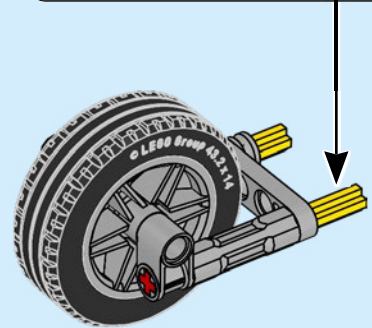
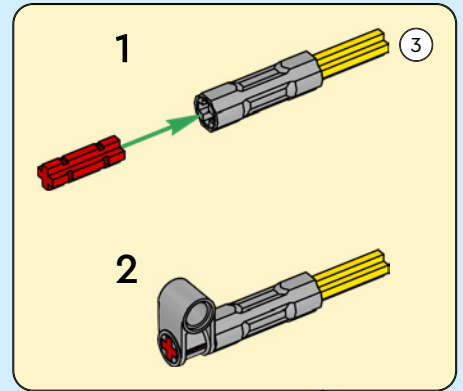

75

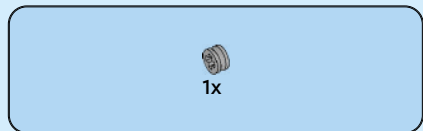
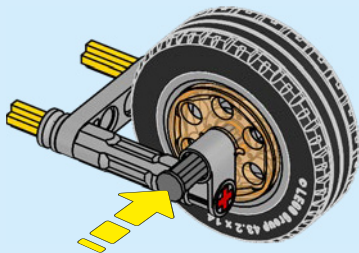
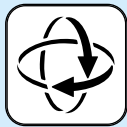

76

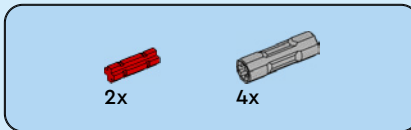
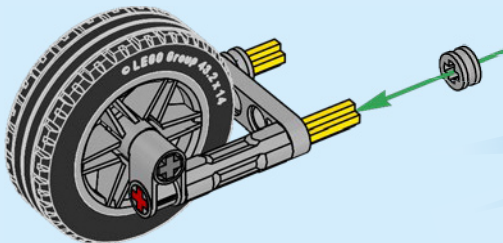

77

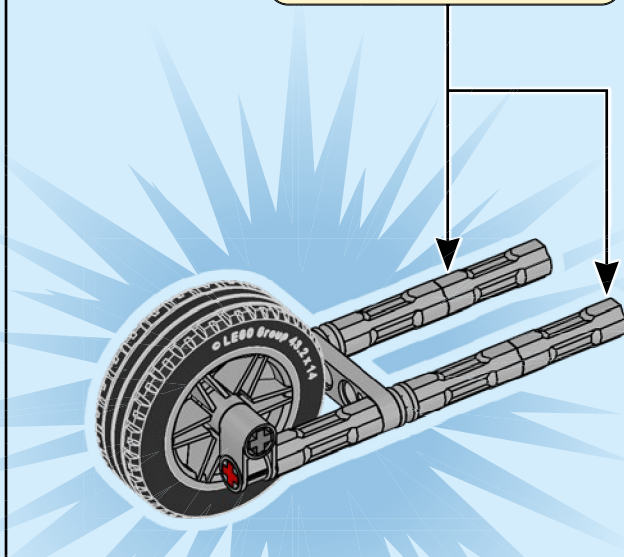
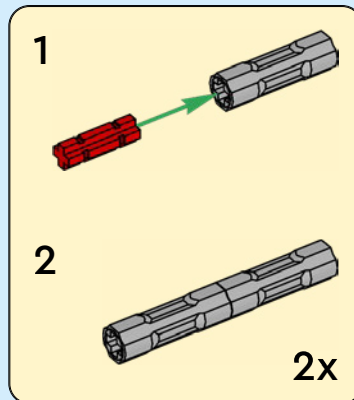

78

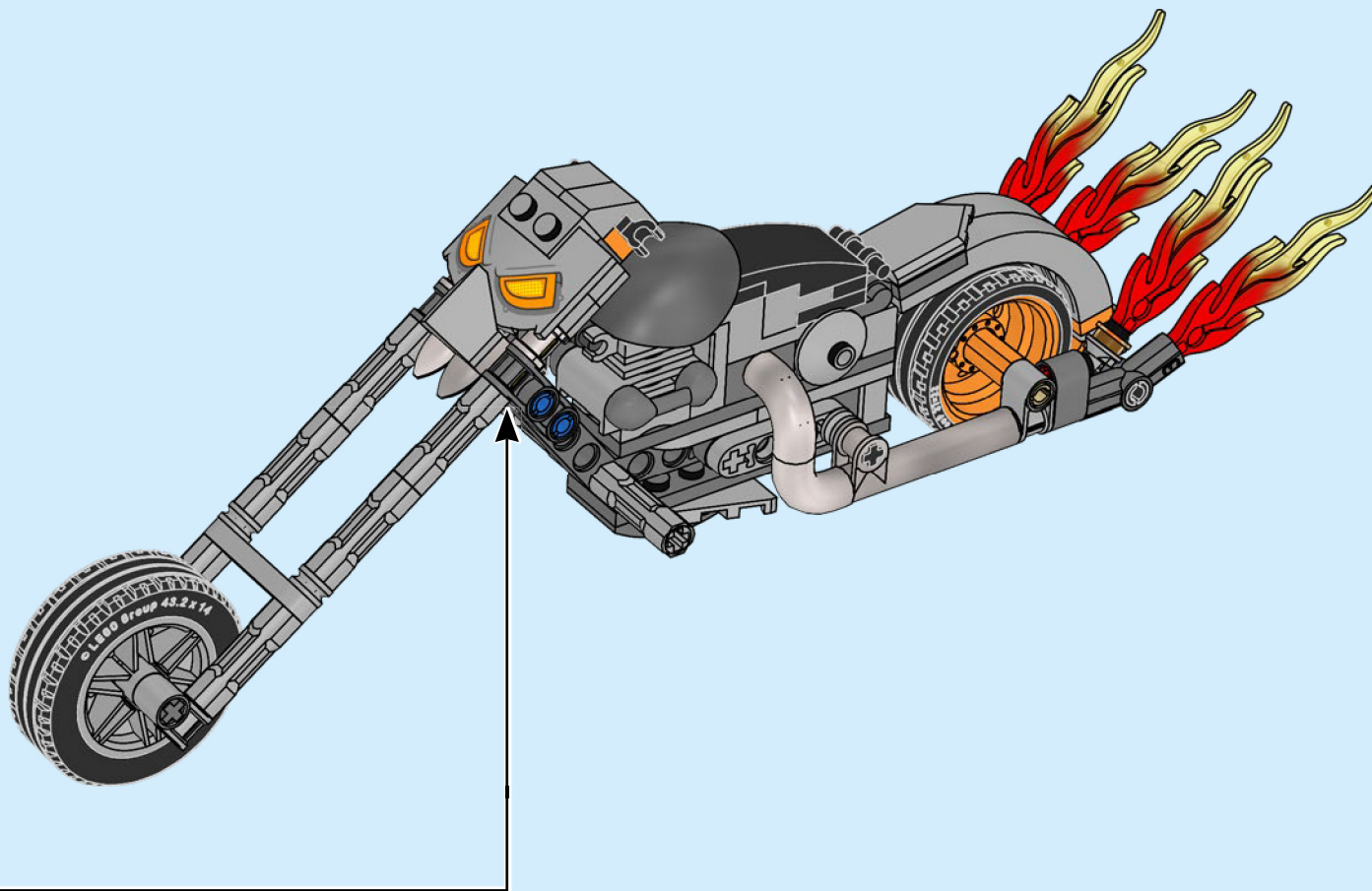

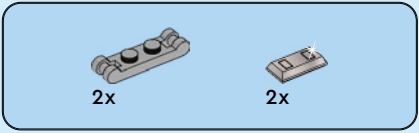

79

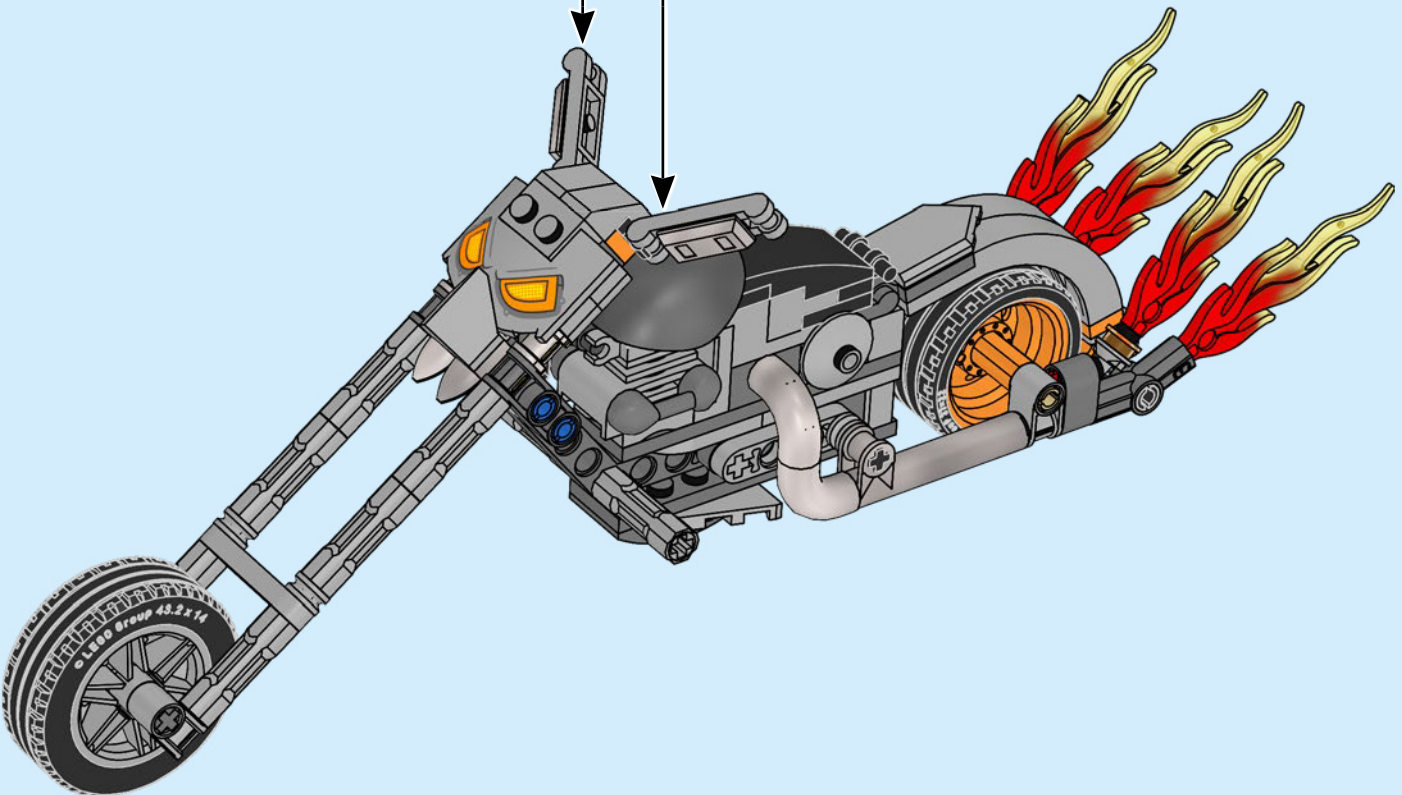
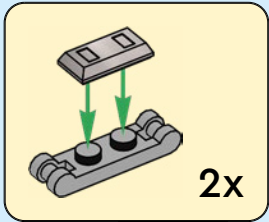

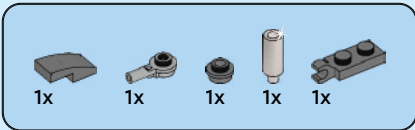

# 80

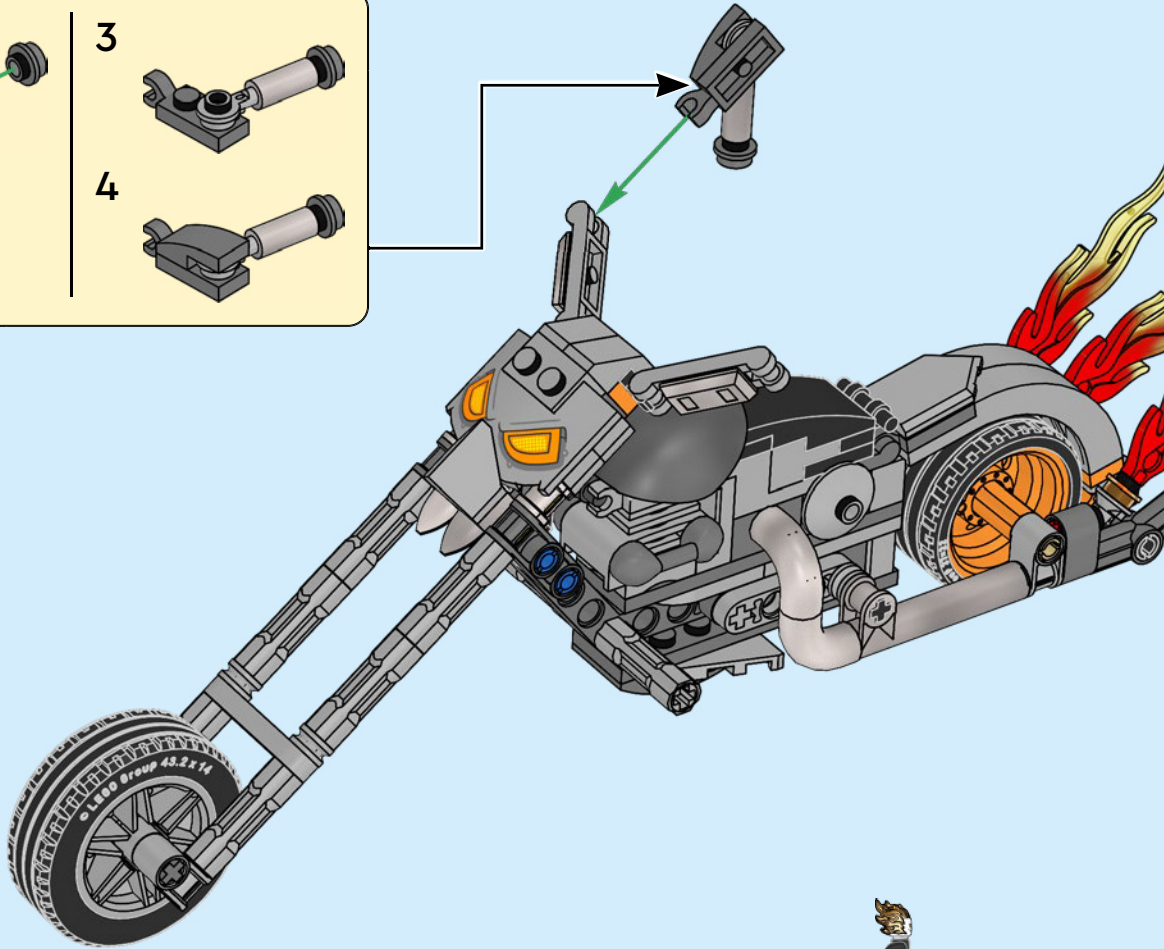
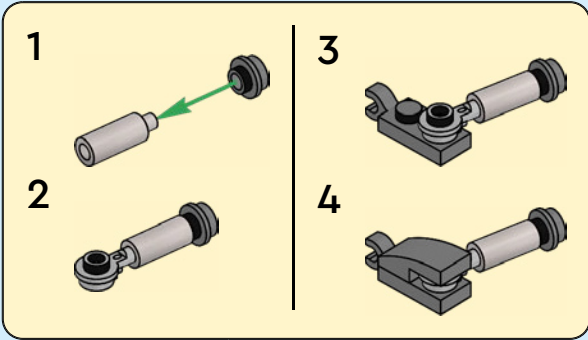

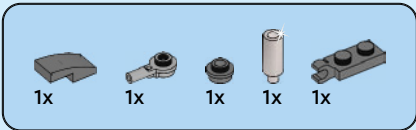

# 81

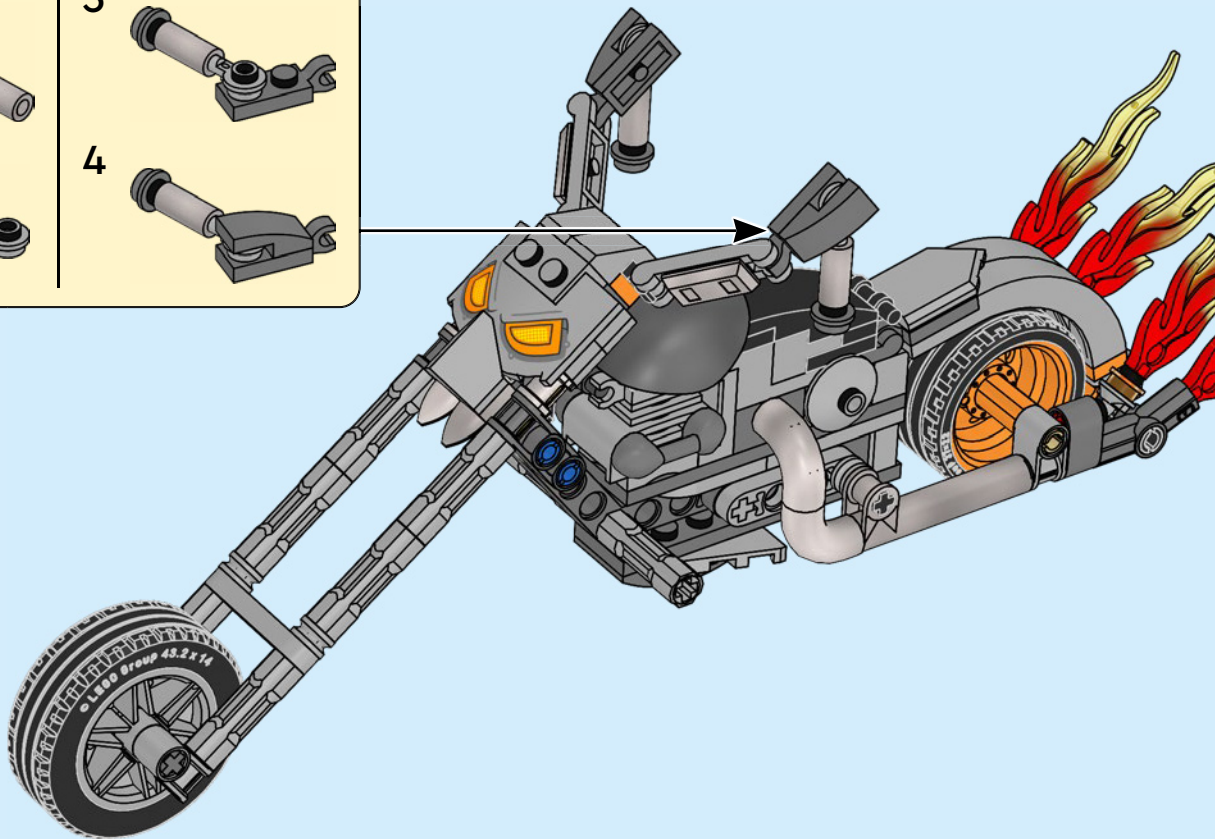
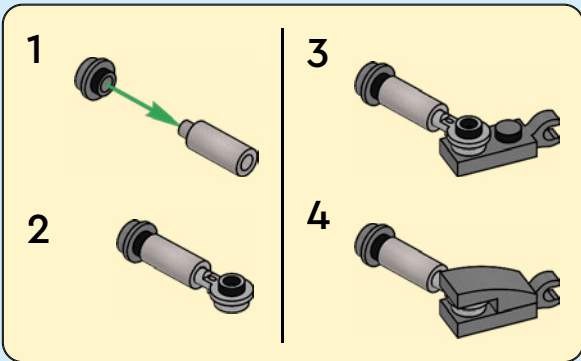

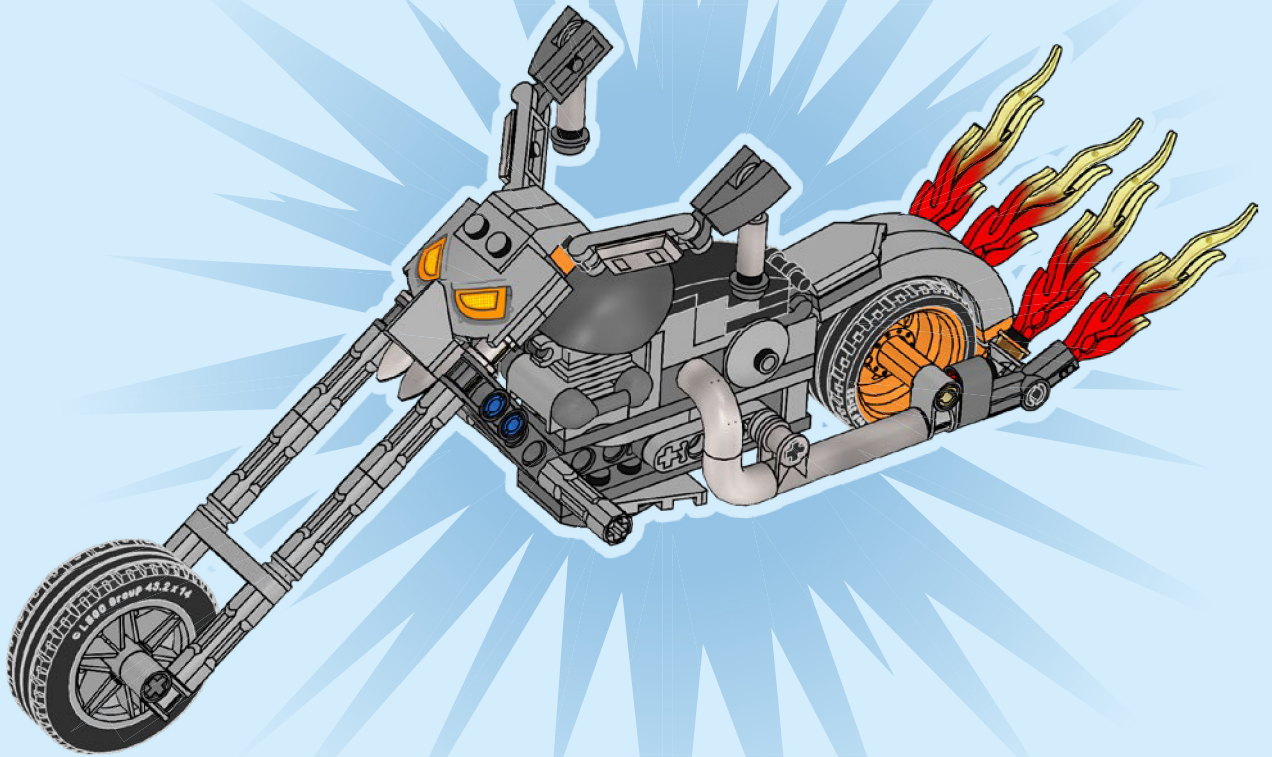

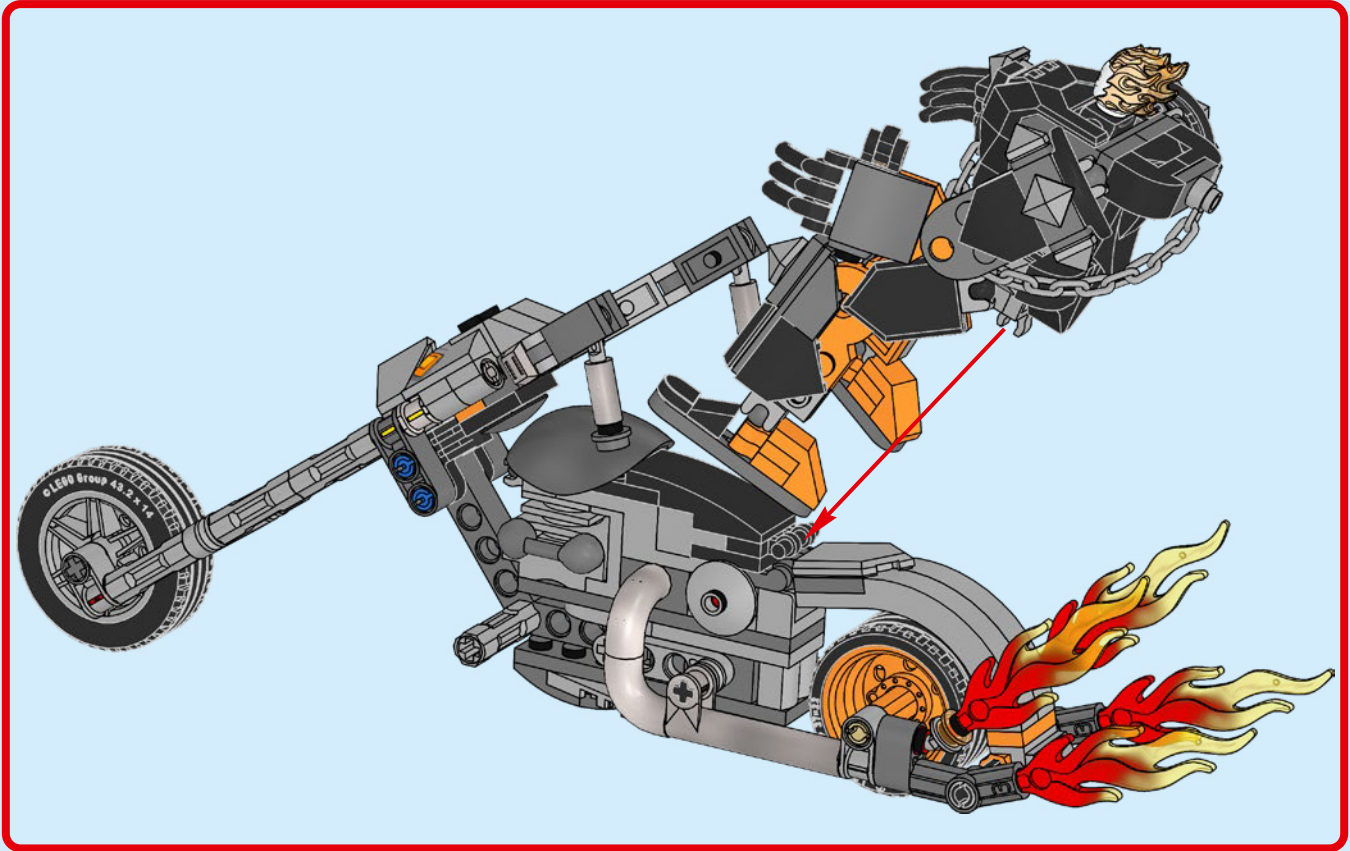



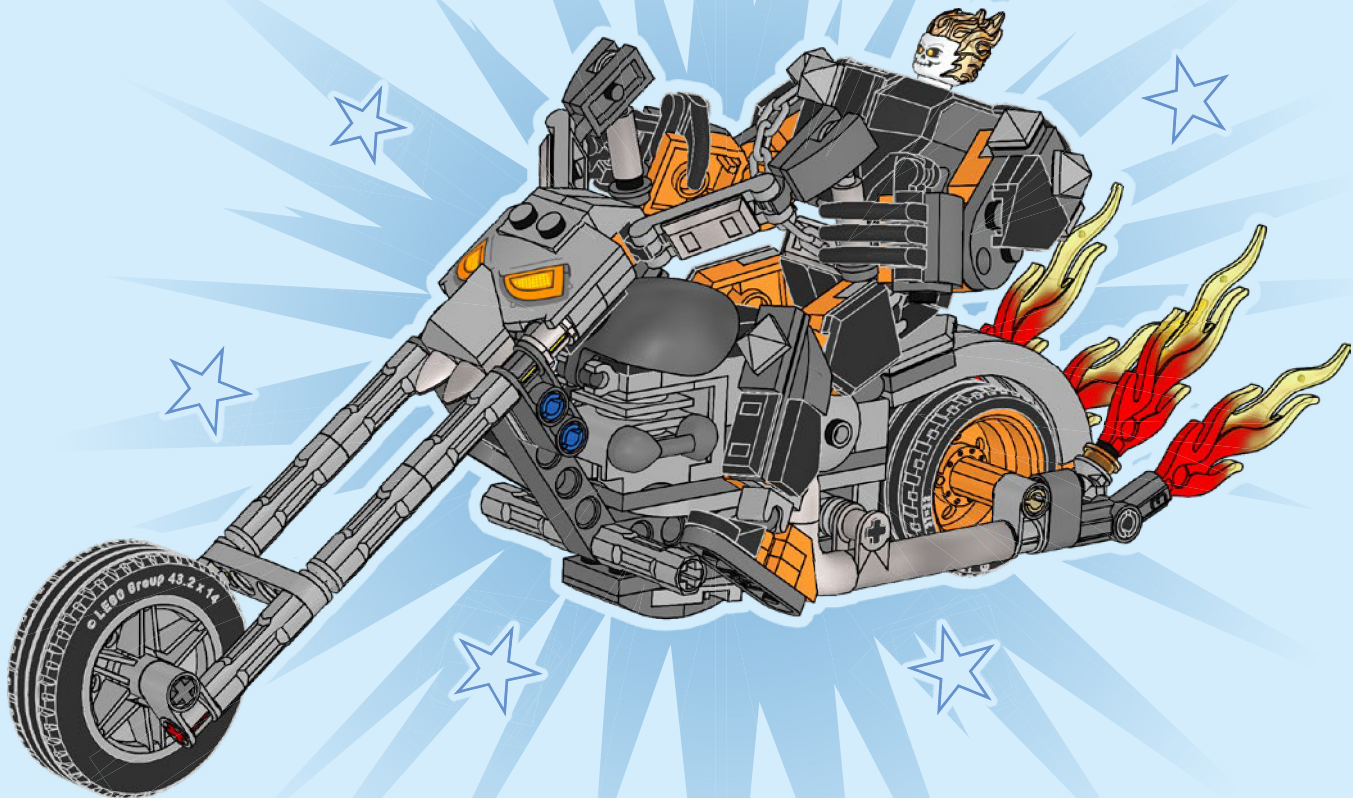



1x  
6421927



1x  
4666579



8x  
6378120



6x  
4142865



1x  
6129995



4x  
4206482



2x  
6256435



4x  
4504382



8x  
6420198



2x  
6380236



2x  
6308000



2x  
6157554



1x  
6279875



1x  
9339

66



4x  
6069000



4x  
6308912



2x  
6156991



4x  
6184784



1x  
4140588



2x  
4225201



1x  
6279021



2x  
302226



1x  
6166859



2x  
6089119



2x  
6245251



1x  
6432420



1x  
6416838



2x  
6255875



1x  
4285883



1x  
6288460



1x  
6182551



1x  
4647286



1x  
302026



1x  
4499234



1x  
370626



4x  
6172283



2x  
4157103



4x  
6352223



2x  
6143028



2x  
6181314



3x  
4177932



1x  
6207477



4x  
6372446



2x  
6174023



2x  
6430977



5x  
6271165



2x  
6326748



11x  
6258381



2x  
6227897



4x  
6261375



1x  
6075075



2x  
4211512



1x  
4550325



1x  
4653091



2x  
6213378



6x  
6043656



1x  
4593679



1x  
6313114



1x  
6248492



4x  
6168633



2x  
4211440



2x  
4654582



1x  
6337268



2x  
6326478



1x  
4211815



8x  
6273212



1x  
6245254



1x  
4211419



3x  
6370947



2x  
6093058



1x  
6383961



1x  
4541318



1x  
6170521



1x  
6421740



1x  
4211395

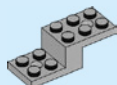

1x  
6028811

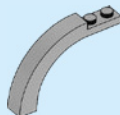

2x  
6286503

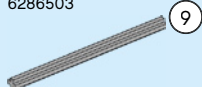

2x  
4535768



2x  
6231765



1x  
6204668



6x  
6225494



2x  
6364352



1x  
6204667



1x  
4278274



2x  
6265093



5x  
6092572



4x  
6178919



2x  
6029948



1x  
6000606



6x  
6336990



2x  
6306725



2x  
4210676



5x  
6130007



2x  
6146321



2x  
6123814



2x  
6273715



2x  
6344820



2x  
6071261



2x  
6366184



1x  
6324639



2x  
4225733



2x  
6271127



2x  
6083620



2x  
6306725



2x  
6306725



2x  
6306725



1x  
6384443



1x  
6384443

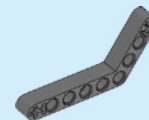

1x  
6279883



2x  
4210997



1x  
6423977



1x  
6292172



2x  
6336564



2x  
4625146



4x  
6335563



3x  
6208446



2x  
6287673



2x  
6395637



2x  
6395637

9

4

3



LEGO.com/service

YOU COULD **WIN**



Scan this QR code or go to **LEGO.COM/PRODUCTFEEDBACK** and give us your short feedback about this LEGO® set for a chance to win a cool LEGO prize.

Terms and Conditions apply\*

**DE: Du könntest GEWINNEN.** Es gelten die Teilnahmebedingungen\* **FR: Tu pourrais GAGNER.** Des conditions s'appliquent\* **IT: Potresti VINCERE tu.** Termini e condizioni sono applicabili\* **ES: Puedes GANAR.** Aplican términos y condiciones\* **PT: Poderá GANHAR.** Aplicam-se termos e condições\* **JA: プレゼント付き! 利用規約が適用されます\*** **ZH: 轻松获奖. 条款和条件适用\*** **KO: 상품의 주인이 되어보세요. 소정의 약관이 적용됩니다\*** **RU: Вы можете ВЫИГРАТЬ.** Действуют положения и условия\* **PL: Szansa na WYGRANĄ.** Obowiązują warunki korzystania\* **CS: Máte šanci VYHRÁT.** Platí všeobecné smluvní podmínky\* **SK: Máte šancu VYHRAŤ.** Platia všeobecné zmluvné podmienky\* **HU: TE IS NYERHETSZ.** Felhasználási feltételek érvényesek\* **RO: Ai putea CÂȘTIGA.** Se aplică termeni și condiții\* **BG: Можете да СПЕЧЕЛИТЕ.** Има определени правила и условия\* **LV: Tu vari LAIMĒT.** Ir spēkā noteikumi un nosacījumi.\* **ET: Sul on võimalus VÕITA.** Kehtivad tingimused\* **LT: Jūs galite LAIMĖTI.** Taikomos sąlygos\*

\*LEGO.com/productfeedback-terms